



By Appointment to
Her Majesty The Queen
Supplier of Fire Detection Equipment
Kentec Electronics Ltd. Dartford

Life Safety
System
Specialists

Brochure
2017 - 2018

Contents

Introduction	3	32	Sigma CP-A AlarmSense Conventional Fire Alarm Control Panels
Our In-house facilities	4	34	Sigma Matrix Conventional Fire Alarm Mimic Display System
Taktis Analogue Addressable Control Equipment	6	36	Sigma CP Network Diagram
Taktis Fire Analogue Addressable 2-16 Loop Control Panels	8	38	Sigma XT Extinguishant Control Panel
Taktis Vision Analogue Addressable Annunciators	10	40	Sigma XT+ Extinguishant Control Panel Multi-Area
Taktis Voice Fire and Voice Control Panel	12	42	Sigma Si Extinguishant Status & Ancillary Units
Taktis Voice Voice Evacuation Panel	14	44	Syncro XT+ Extinguishant Control Panel Multi-Area Addressable
Taktis Virtual Resource A Comprehensive Suite of Software Based Tools	16	46	Sigma XT Network Diagram
Taktis Configure Loop Explorer 2 (LE2) Configuration Software	18	48	PSU's Power Supplies
Taktis Network Diagram	20	50	Miscellaneous Items
Syncro AS Analogue Addressable 1-2 Loop Control Panels	22	52	Elite RS Analogue Add. Fire Control Panels & Repeaters UL/ FM Approved
Syncro Repeaters Analogue Addressable Fire Control Panel Repeaters	24	54	Sigma A-CP Conventional Control Panel UL Approved
Syncro Matrix Intelligent Fire Alarm Mimic Display System	26	56	Sigma A-XT Extinguishant Control Panel UL/ FM Approved
Syncro Network Diagram	28	58	Sigma A-Si Extinguishant Status & Ancillary Units UL/ FM Approved
Sigma CP Conventional Fire Alarm Control Panels	30	60	Syncro ASM Marine & Offshore Analogue Addressable 1-2 Loop Control Panel
		62	Custom Custom Engineered Solutions

Life Safety System Specialists

Founded over 30 years ago Kentec Electronics Ltd has worked closely with their customers and end users enabling it to become a World leading life safety control systems manufacturer. The Kentec name has become synonymous with World Class products, great service and excellent support. Based in the UK, Kentec is a truly global supplier, exporting control equipment to over 90 countries Worldwide and in many different languages. Kentec now manufacture products approved to EN54, NFPA and marine classification societies.

At the heart of our success is our philosophy of in-house Research and Development, manufacturing and continuous investment. Recent expansion of our Dartford based facility has seen the installation of a second surface mount machine, new selective solder machinery, improvements to our paint shop and in-house print room as well as multiple other improvements. All this investment has been to ensure continued high quality of product and on time delivery. With the popularity of Kentec equipment growing rapidly it has been essential to invest to meet our own high standards. Our focus is on customer service and we pride ourselves on quick turnaround and our ability to react quickly to customer requirements and market trends.

Kentec offers the most comprehensive range of conventional, analogue addressable fire detection and extinguishant control panels available. Our custom build service is also highly regarded in the industry and utilises our expertise in control panel technology to design and build high quality product to exacting customer specifications. Marine products are now an important part of our product portfolio.

At Kentec we believe that the quality of our products should be paramount; rigorous testing procedures are employed at every stage of the manufacturing process to ensure that all equipment is supplied to the highest standards. For this reason we are confident in offering an industry leading 3 years warranty on all product that we supply. We also understand that service is a key part

of how a manufacturer's quality is judged. To this end we have invested extensively not only in our manufacturing facilities but in our support team including technical support and training.

At Kentec investment in the future is not confined to factory improvements as the company continues to increase the size of the R&D department which recently moved into a new purpose build facility in Rochester. This investment ensures the continuing product innovation that Kentec is known for.

Having worked closely with customers and end users for 30 years Kentec has the experience to develop simple to use, easy to set-up panels which save commissioning engineers time and allow end users to have full confidence in the safety systems they have selected.

As part of our customer care Kentec offers first rate technical support facilities and a dedicated team of highly trained personnel provide direct telephone assistance; this is backed up by regular technical e-mail bulletins. We also have a team of dedicated trainers who provide our customers with product training both onsite and offsite, UK and overseas. Kentec has recently kitted out and opened an additional training room to cater for the demand from customers.

Kentec's products are tested and approved to international standards such as EN54, EN12094, UL and FM.

Kentec achieved 'Investors in people' accreditation in 2004. Our management systems are ISO 9001:2008 approved and our policy for environmental awareness was officially recognized in 2007 when we gained our ISO 14001 certification from BSI. In 2008 Kentec was proud to be awarded the Royal Warrant of Appointment by Her Majesty The Queen.



Certificate No. FM 32987
BS EN ISO 9001:2008



Certificate No. EMS 518118
BS EN ISO 14001:2004



Certificate No.960
BS EN ISO 9001:2008



KM 73505
KM 96761

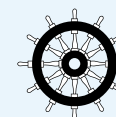

Our In-house Facilities

At the heart of our business lie the many in-house facilities that are at our disposal. From the initial design process, to sheet metal fabrication, to powder coating and printing through to panel construction, we have full control at every stage of our manufacturing process allowing us to offer industry leading delivery times and with quality that you can have confidence in.

Our Dartford based “World Class” facility is continually being enhanced and expanded to meet growing customer demand and utilise the latest manufacturing techniques.

Integral to our sheet metal fabrication department are the two state of the art computer controlled Amada break presses which turn sheet steel into Kentec panels. We also have a full range of bending, cropping, studding and welding equipment allowing us the capability and flexibility to produce single items or volume product.

Our versatile finishing department which features a semiautomatic powder coating plant continues to provide all our metal component finishing needs.

Our printing department deploys state of the art digital printing with the centre piece being our OCE Arizona digital UV large format printers. The Arizona printers have revolutionised the department offering increased capacity, consistency and quality.





Electronic Sub-assemblies are produced using our fully automated surface mount production lines which were enhanced in 2015 with the addition of a second automated line. Up to date Selective Soldering machines carry out the majority of our soldering. We systematically utilise both optical and electrical automatic test equipment to ensure each and every assembly is built to the same high standard and is fault free.

All panels supplied by Kentec are manufactured and assembled in-house in the U.K. Before despatch all panels undergo a rigorous testing procedure, they are then given a final visual inspection.

To underpin our industry leading in-house manufacturing activities we employ teams of qualified and experienced mechanical, software and electronic hardware developers and technicians dedicated to both new product developments and existing on-going product support.



Taktis Overview

The all new Taktis product range of fire alarm control equipment combines the very latest hardware and software to produce a control and indication system, which is powerful and sophisticated, yet simple to use and understand.

The flexibility of the Taktis platform is such that it can be re-configured to realise many other control and indication applications, with direct integration into intelligent buildings.

Moving away from the simple, price driven competitive model used by most manufacturers today, the Taktis concept is designed to add value to System Designer, Integrator, Service provider and the end user.

Developed from the "ground up" by one of the industries' leading design teams and using some of the most advanced technology available, Taktis is designed as one of the most powerful, intelligent and technically robust fire alarm products available.

Not only do the products and services offered under the Taktis brand provide solutions to the most technically challenging applications in life safety, Taktis will deliver added value, market advantage and a competitive edge to your business.

The modular nature of the Taktis system allows all field wiring to be connected to a passive mother board enabling addition, re-configuration or replacement of all electronic hardware without the need to disconnect any field wiring.

This modularity also allows each panel to be customised with addressable loop detection circuits, conventional detection circuits, relay cards, additional sounder outputs or programmable I/O modules as required.

Each 2 loop module slot can be fitted with a variety of option boards to provide alternative functionality. Modules can be "hot swapped" to minimise system degradation during fitting and all inputs and outputs can contribute to the Taktis, industry-leading cause and effect capability.

These modules include:

- 8 zone conventional detection board
- 4 way sounder output board
- 8 way volt free relay contact board
- 16 channel programmable I/O board with digital inputs and open collector outputs
- Media Gateway communications board
- Taktis "Bridge" Network Card (connect Taktis to your existing Syncro network)

By taking advantage of the unique user interface it is possible to further customise the control panel so it can meet specific alternative requirements such as local regional variances, alternative additional functionality or corporate livery. Although this level of customisation is not generally a user feature, the architecture of the Taktis control system makes customisation almost limitless.



Taktis Features

- Compliant with EN54-2, EN54-4 and EN54-13
- Detector protocol selectable via front panel menu screens
- Up to 144 zone LED indicators on standard models
- Support for up to 2000 zones and zone LED indicators
- Built in programmable I/Os
- Up to 512 programmable I/O via optional plug in cards
- Modbus, LonWorks and BACnet interface options
- Full colour, 7" 800 x 480 touch screen graphical display
- Fully automatic display brightness adjustment
- 80 character point and zone text
- Over 4000 sub address points per panel
- Over 5000 cause and effect outputs
- Over 20,000 cause and effect entries
- Up to 5000 software groups
- Maximum of 50,000 devices NOT and TIME as well as COINCIDENCE, OR and AND operators in cause and effects
- Option to "invert" inputs and outputs
- 9999 event log with one second resolution
- Powerful, standard configuration templates
- Network up to 128 panels
- Configurable via USB port to PC or memory stick
- Optional Media Gateway communications card

Taktis Overview

With the increasing demands for power in fire detection and alarm systems, Taktis Fire control panels are well placed to meet current and future needs.

All panels are available with either a 5.25A, 24V power supply capable of charging up to 25Ah batteries or a 10.25A, 24V power supply capable of charging up to 45Ah batteries. Taktis Fire can be supplied with one of a range of remote power supply units making the control panel smaller and easier to install.

Up to 500 milliamps is available for each detection loop allowing for a generous quantity of loop powered devices.

The four sounder circuits are each capable of supplying up to 2.5A at 24V to audio and audio visual devices.

The addition of a Taktis Media Gateway communications device configured to report to the Virtual Resource servers and subscription to one or more Virtual Resource browser based software modules, allows systems to be managed remotely and from any location in a simple and efficient manner.

Taktis Media Gateway also provides the interface between control systems and other products and utilities such as PC graphics, Voyage Data Recorder and a growing number of third party Taktis compatible products.

Configurable serial ports will allow connection to BMS systems using LonWorks, Modbus or BACnet protocols.

Taktis Fire systems are scalable with Taktis Net Enhanced High Speed Networking. This allows up to 128 panels to be connected together as a fully fault tolerant networked system with rapid inter panel communications and up to 1.2km of standard two core fire resistant cabling between nodes.

Each panel can be configured to display all or any events from any other panel allowing master/slave, multiple master/slave or peer to peer configuration.

Sophisticated network analysis tools provide the ability to identify connection problems instantly and the commissioning mode allows individual panels to be prevented from transmitting events to the network while maintaining communications.

Adding a Taktis "Bridge" Network Card to your Taktis Panel or Taktis Network provides an interface between existing Syncro and Taktis Control Systems providing backward compatibility and a unique upgrade path.

Compatible Equipment & Extras



Selection of I/O boards



VR Taktis Media Gateway



Taktis Network Card



Taktis Fire 2-16 Loop Panel



Taktis Vision Features

- Robust, full colour, 7" 800 x 480 touch screen graphical display
- Full indication of all information displayed at the fire control panel
- Automatic display brightness adjustment
- Silenceable internal sounder
- Connections Via:
 - Control panel RS485 bus
 - Option to connect to control panel network
- Low current, 24V DC powered
- Slim compact construction
- Configurable functionality
- Configurable languages
- Optional Enable keyswitch

Taktis Vision Overview

Taktis Vision provides a means of allowing full display and optional control of the Taktis Fire Alarm control panel from a small and unobtrusive local control station.

Based on an all new hardware and software platform, the large, full colour graphical display with touch screen functionality, delivers information on the status of the fire alarm system to single or multiple locations.

Taktis Vision repeaters can be configured to offer full display and control to replicate the functionality of the Fire Control panel or to operate as a simple, display only device for applications where access to control the Fire Alarm system would be inappropriate.

For other annunciation and control applications, Taktis Vision can be configured to provide customisable switches and indications for a host of fire system ancillary functions.

Taktis Vision may be connected to the fire control panels' fault tolerant, ancillary RS485 bus or to the fire alarm panel fault tolerant network using standard, fire rated cable offering flexibility in system wiring.

Available in several standard formats, Taktis Vision can be mounted directly onto a wall, be recessed using our quick-fix adaptor frame or fully flush mounted. Special enclosure finishes and colours are also available to match existing decor.

Compatible Equipment & Extras



Taktis Network Card



Multi Purpose Flushing Collar

COMING
SOON



Taktis Voice Features

Amplifier/Outputs

- Four band parametric plus bass and treble equalisation
- Loudspeaker A and B operation mode
- DC line or Impedance speaker monitoring
- Transformer-less plug-in amplifiers – conveniently fits into a Taktis panel
- One to one standby operation or autonomous operation
- Programmable for 70V/100V RMS operation
- Programmable power limited 25W, 50W (for 50W), 75, 100W (for 100W)
- Speaker Class A (loop) or Class B (spur) wiring operation

Audio Inputs

- High quality audio with sampling frequency 48KHz
- 4 versatile balanced analogue audio input (2 MIC, 2 0db lines).
- Mic input supports PTT and speak now interface with fail safe mic operation

Message/Tone store

- All call emergency fail safe message
- Up to 120 minutes/tone flash stored digital message
- Up to 12 message/input priority levels

Supported Peripherals

- Remote volume control
- Cap ambient noise sensor
- A wide range of RS485 remote paging or fire microphone units
- Voice over IP (VoIP) remote paging or fire microphone inputs
- Background music over VoIP

Taktis Voice Overview

The Taktis Fire and Voice combo panel is a truly integrated Fire and Voice panel in one enclosure. This seamless integration is such that the proven Taktis Fire subsystem provides 'the cause' and the voice subsystem responds with a preconfigured announcement – 'the effect'.

The Taktis Fire and Voice combo panel uses the same versatile Taktis technology and allows users to fit (in addition to the fire plug-in cards) a digital message plug-in card and a choice of 50W or 100W dual amplifier cards to deliver public address and voice alarm messages. The public address and Voice Alarm subsystem may be manually controlled and managed through an intuitive touch screen front panel console. This console is supplied with 10 zone/paging buttons as standard but can be expanded to 25, 40 and 55 buttons by additional consoles. These selection buttons are fully programmable and may be configured to play any combination of messages into selected speaker circuits.

The combined panel meets the requirements of EN54-16, EN54-2 and EN54-4 and includes in-built listen-in speaker, paging microphone and a choice of 5.25A or 10.25A power supply. The panels may be connected to 32 Voice Alarm panels and/or 127 Fire Alarm panels to form a distributed network with the ability to play 6 concurrent and synchronised messages across the network.

Compatible Equipment & Extras



Taktis Network Card

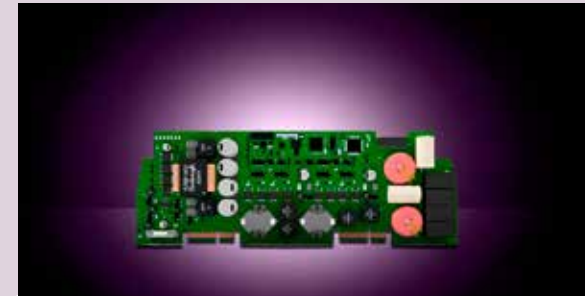

Amplifier Card

COMING
SOON



Taktis Voice Features

Amplifier/Outputs

- Four band parametric plus bass and treble equalisation
- Loudspeaker A and B operation mode
- Option for DC line or Impedance speaker monitoring
- Transformer-less dual plug-in amplifiers – conveniently fits into a Taktis panel
- One to one standby operation or autonomous operation
- Programmable for 70V/100V RMS operation
- Programmable power limited 25W, 50W (for 50W), 75, 100W (for 100W)
- Speaker Class A (loop) or Class B (spur) wiring operation

Audio Inputs

- High quality audio with sampling frequency 48KHz
- 4 versatile balanced analogue audio input (2 MIC, 2 0db lines)
- Mic input supports PTT and speak now interface with fail safe mic operation

Message/Tone store

- All call emergency fail safe message
- Up to 120 minutes/tone flash stored digital message
- 6 channels concurrent message playback
- Up to 12 message/input priority levels

Supported Peripherals

- Remote volume control
- Cap ambient noise sensor
- A wide range of RS485 remote paging or fire microphone units
- Voice over IP (VoIP) remote paging or fire microphone inputs
- Background music over VoIP

Taktis Voice Overview

The Taktis Voice Alarm panel compliments the Taktis Fire Alarm control panel over a high speed network. The Taktis Fire Alarm control panel provides 'the cause' and the distributed voice alarm panel responds with a preconfigured announcement - 'the effect'.

The Taktis Voice Alarm panel uses the same versatile Taktis technology which allows users to fit a digital message plug-in card and a choice of 50W or 100W dual amplifier cards to the Taktis back plate to deliver public address and/or voice alarm. The public address and Voice Alarm subsystem may be manually controlled and managed through an intuitive touch screen front panel console. This console is supplied with 10 zone/paging buttons as standard but can be expanded to 25, 40 and 55 buttons by additional consoles. These selection buttons are fully programmable and may be configured to play any combination of messages into selected speaker circuits.

The panel meets the requirements of EN54-16 and EN54-4 and includes in-built listen-in speaker, paging microphone and a choice of 5.25A or 10.25A power supply. The panels may be connected to 32 Voice Alarm panels and/or 127 Fire Alarm panels to form a network with the ability to play 6 concurrent and synchronised messages across the network.

Compatible Equipment & Extras



Taktis Network Card

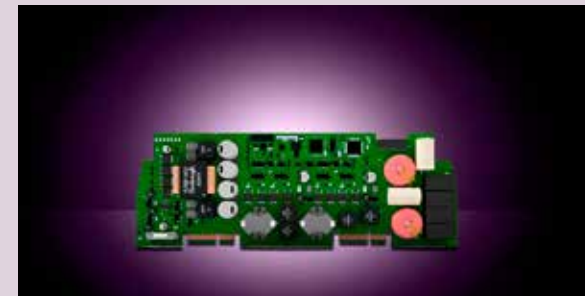

Amplifier Card



Additional Slave Module



Vision Window kit available

Taktis Virtual Resource | A Comprehensive Suite of Software Based Tools

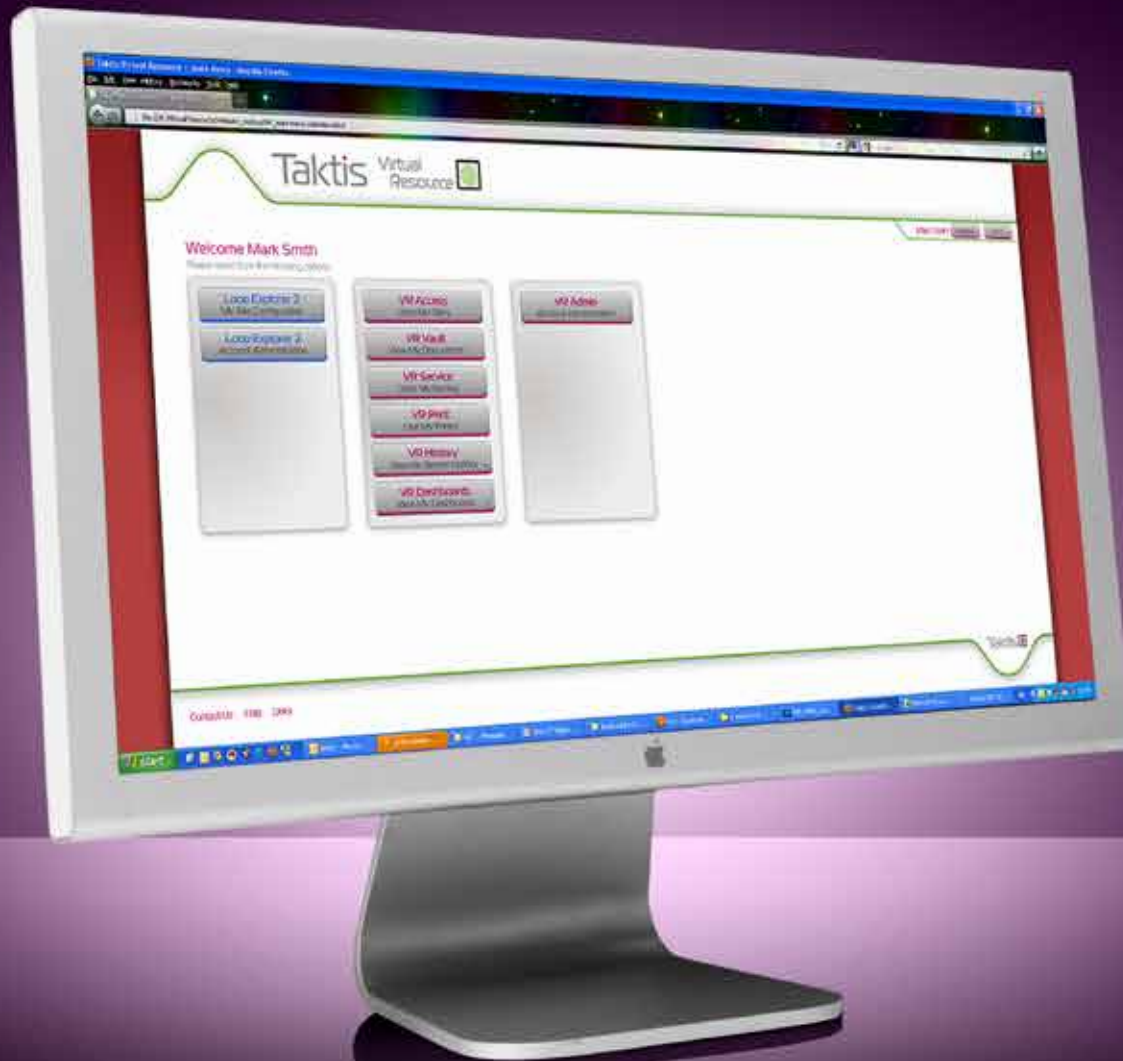

Taktis VR Features

- Unique Life Safety management utility
- Remote access to system data from anywhere
- Revenue driver for all business sizes
- Cut costs and drive up productivity
- Reduce environmental impact through technology
- Modular application based tool set:
 - VR Access - View and manage my projects
 - VR Vault - Store and retrieve system documentation
 - VR Service - Manage, add value and improve compliance
 - VR print - Virtual printer
- More to come...
More VR applications will be added to the list providing users with further enhancement to their value and revenue streams

Taktis VR Overview

To compliment the new, market leading range of control systems, Virtual Resource is a unique suite of software tools aimed to deliver a whole new dimension in Life Safety System Management.

It provides System Designers, Integrators and Service Companies with the ability to remotely access and comprehensively manage any system using intelligent analysis of data collected from those systems. End-users and facilities managers can also greatly benefit from the powerful feature set that comes with Virtual Resource.

Virtual Resource is based on technology successfully trialled for many years and is one of the most technically advanced management tools for fire detection and other safety systems on the market.

With Virtual Resource, Installers and Service providers are able to offer market leading functionality through remote management and provide improved service at lower cost and greater efficiency.

The remote management features offered by Virtual Resource can result in reduced fault call outs, improved servicing regimes, more effective maintenance, reduction of unwanted alarms and improved overall service to the end user.

Whether you are a Service provider, building owner or facilities manager, change the way you think about managing your Fire Detection System. Taktis VR you can reduce costs, add value and improve service integrity by employing the latest communication and analytical technologies.

VR Access

Gain access to data from all of your systems, assess performance, check status and make decisions based on facts, not assumptions.

VR Access allows a Virtual Resource enabled fire system to periodically report its status to the secure servers and allows a VR Access subscriber to view the latest status report via any web enabled device.

VR Vault

Subscribers to Virtual Resource can securely store system and site related documentation on our permanently backed up servers using VR Vault.

VR Vault provides a convenient and permanently accessible storage location for all documentation related to an installation including installation drawings, commissioning details and certificates, service and maintenance records, general notes and any other documents related to the installed system that the user requires.

VR Service

VR Service provides a means to set up a comprehensive fire alarm system servicing regime adding benefit to both the end customer and Service company.

Site details can be imported from VR Access or added and set up manually to create customer records.

Service frequency and device activation list schedules can be set and resources allocated including, travelling time and estimated time to complete the service providing essential data for planning service engineer's activities. Service engineers can view and print their work schedules including site specific notes and previous service records directly from the system if required.

VR Print

Designed to replace panel mounted printers which are inherently difficult to manage and provide very limited information. VR Print provides a secure method of storing and recalling the control system events via any web browser. The user can simply view the systems events on line, print PDF reports or download the data in formats such as csv for further data analysis.

Taktis Configure

Loop Explorer 2 (LE2) Configuration Software



Taktis LE2 Features

- Based on the industry leading Loop Explorer
- Delivered and managed via the new taktisvr.com web site
 - No more out of date versions in circulation
- Many new features and benefits
 - Time manager
 - Group Manager
- 1000's of Cause & Effect options
- Additional C & E operators
 - "Not" and Time
- Powerful templates
- Favourite device tab
- Language support

Taktis LE2 Overview

The powerful central processor and extensive on board expandable memory in the Taktis Fire control system, allows demanding configuration options and many thousands of cause and effects to be processed quickly and efficiently.

Logical operators such as COINCIDENCE, AND, OR, NOT, TIME OF DAY and INTERVAL TIME along with the ability to group inputs and outputs into collections other than zones and the capability to configure up to 2000 zones produces a system capable of fulfilling the most demanding of control applications.

A standard USB port allows configurations stored on a USB memory stick to be loaded to the control panel without the use of a PC.

The Loop Explorer 2 (LE2), PC configuration software provides a familiar, simple to use PC application with the power to produce the most complex configurations via an easy to use and intuitive interface.

Maintaining the look and feel of the industry leading original Loop Explorer I configuration utility, LE2 is itself highly configurable allowing customisation of languages, colour schemes and company logos and allowing exposure to single or multiple detector protocols to be set for each user.

Additional logical operators for NOT and TIME functions for use in cause and effects and the inclusion of "groups" (collections of devices not necessarily in the same zone) increase the power and flexibility of LE2 to far beyond what was achievable with its forerunner and most other products currently on the market.

LE2 can also be used to select, (where applicable) the appropriate detection loop protocol. It is possible to run different loop protocols on individual loop cards.

Powerful standard templates allow rapid configuration of common fire system configurations for applications such as high rise buildings or alarm verification from hotel rooms.

Cause and effect processing power is now practically limitless allowing the configuration of large, complex networks with ease. Access to LE2 is via a secure web server, so users with the appropriate credentials have permanent access to the latest version ensuring that the most recent enhancements are always available. LE2 can be customised by the user so that language or specific terminology can be set as defaults for all systems that are configured using LE2. Custom changes are stored on our servers, once more ensuring that all authorised users have access to the latest customised version.

For added convenience, Taktis Virtual Resource subscribers can store LE2 configuration files on our secure servers ensuring that the site configuration is always backed up and available to users with the appropriate access rights.

Taktis Network Diagram

High Integrity Configurable Network

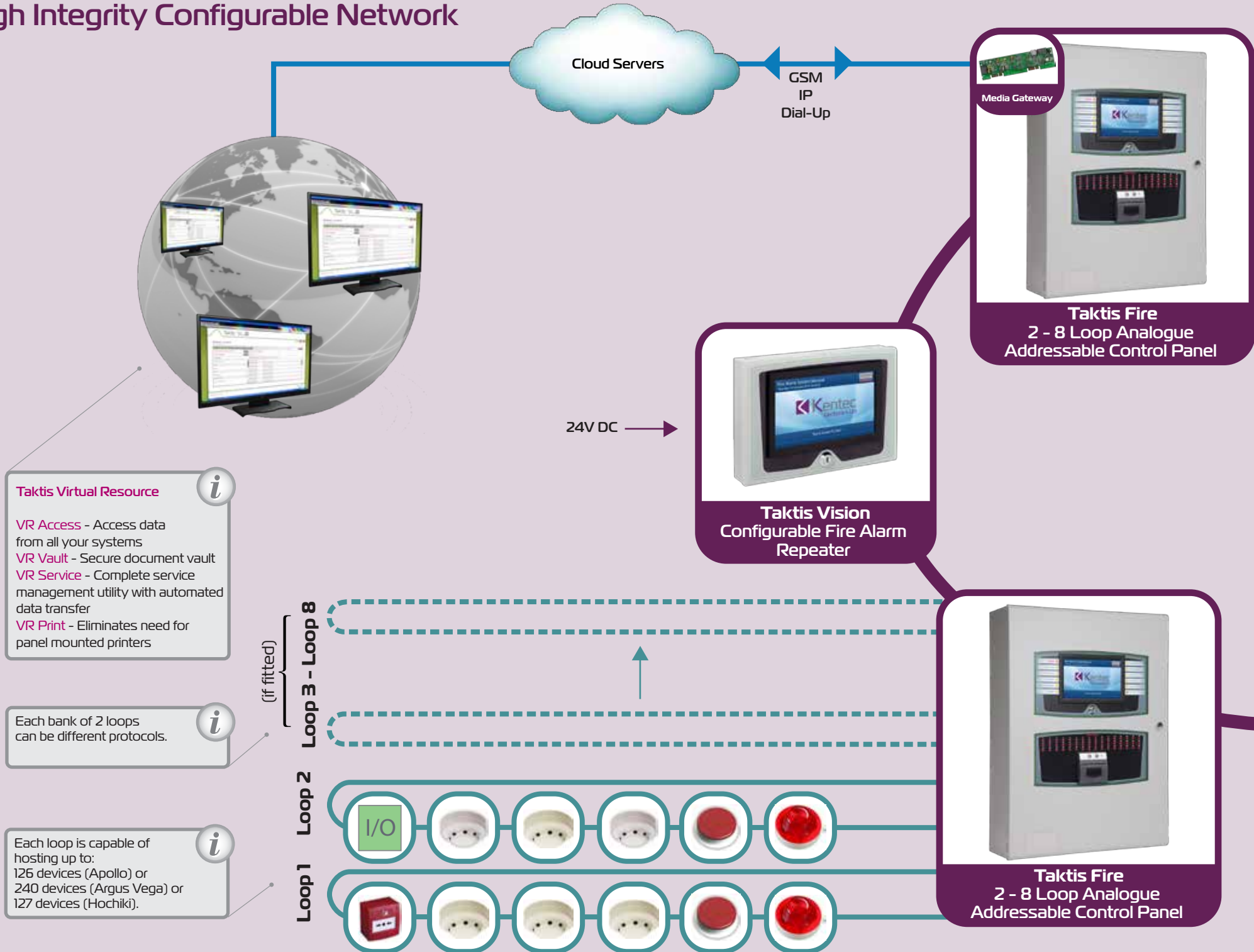

Taktis Virtual Resource

- VR Access** - Access data from all your systems
- VR Vault** - Secure document vault
- VR Service** - Complete service management utility with automated data transfer
- VR Print** - Eliminates need for panel mounted printers

Each bank of 2 loops can be different protocols.

Each loop is capable of hosting up to:
 126 devices (Apollo) or
 240 devices (Argus Vega) or
 127 devices (Hochiki).



Taktis Fire
2 - 8 Loop Analogue
Addressable Control Panel



IO Cards

Plug in
slots



K772
16 Channel
I/O Board



K791
8 Way
Relay Board



K792
8 Way Conventional
Zone Board



K793
4 Way
Sounder Board

RS485 bus



Taktis Vision
Configurable Fire Alarm
Repeater

24V DC

i
The Taktis system is compatible with Apollo, Argus Vega and Hochiki protocols. Panels of any of the above protocols can be used on the same network.

i
Up to 128 Panels/Repeaters can be added to the network.



Taktis Fire
2 - 16 Loop Analogue
Addressable Control Panel



Loop 1 Loop 2 Loop 3 - Loop 16

(if fitted)

i
Each bank of 2 loops can be different protocols.

i
Each loop is capable of hosting up to:
126 devices (Apollo) or
240 devices (Argus Vega) or
127 devices (Hochiki).

Syncro AS

Analogue Addressable 1-2 Loop Control Panels



Syncro AS Features

- 16 zonal LED indicators
- 2 programmable sounder circuits
- 5 programmable inputs
- 3 programmable relays
- 3A power supply
- Large graphic display
- Real time clock
- Expandable from 1 to 2 loops*
- Certified to EN54-2/ EN54-4
- Up to 512 additional programmable I/O via Syncro I/O modules *
- Powerful, network wide cause and effects *
- Sensitivity adjustment and Drift Compensation
- Can be networked with Syncro control panels *
- Compatible with Focus and View repeaters *
- Supports Apollo, Argus Vega and Hochiki protocols
- Same look and feel as Syncro range
- Stores 500 last events in event log
- Dial up modem connection available
- Compact, stylish enclosure
- Installer friendly, removable equipment chassis
- Different language and character set variants available
- Fully EN54-2 and EN54-4 compliant improved front loading Printer option * **

*These items not available on Syncro AS Lite panel

** Can be fitted to M3 size enclosure only

Syncro AS Overview

The Syncro AS is a powerful and versatile Single or two Loop Analogue Addressable Fire Control Panel.

Syncro AS fully supports all devices from the leading, open protocol detector manufacturers and can be supplied with Apollo (S90/XP95 /Discovery), Argus Vega or Hochiki ESP loop drivers, all capable of providing up to 400 milliamps of loop current for the most demanding applications.

An integral 3 Amp power supply and temperature compensated battery charger provides ample power for the two, 1 Amp rated standard sounder outputs, loop powered sounders and other devices.

Syncro AS is also available as a Lite version offering a very cost effective solution for smaller standalone installations requiring only one detection loop.

The Lite version does not support the following:

Second loop, Printer output, Networking and connection of I/O boards or the View repeater.

Connectivity

Syncro AS connects seamlessly to other Syncro AS, or Syncro multi-loop panels and repeaters via the fully fault tolerant and robust Syncro network. The Syncro AS supports all Syncro serial bus peripherals such as View repeaters, 16 channel I/O boards, Relay boards, Sounder boards and Conventional Zone boards to provide an additional 512, fully programmable points. 16 zonal LED indicators are provided as standard and the panel will support up to 500 network wide software zones as per Syncro multi-loop panels.

Powerful Software

Programming, including powerful cause and effect functionality can be achieved using the intuitive Loop Explorer configuration utility familiar to Syncro panel users. The new Loop Explorer 2 will also support all of the Syncro AS product family.

The Guide graphics system or a modem for remote system interrogation by telephone lines may also be connected to Syncro AS panels via the RS232 serial connection.

Ease of Installation

The elegant and simple construction of the panel enables the chassis to be completely dismantled by removing just two screws. The outer cover can also be detached by removing two hinge pins making first fix installation very simple and enabling the sensitive electronic parts to be stored safely for re-fitting at the commissioning stage.

Housed in the same installer-friendly and attractively styled enclosure as the popular Sigma CP (Conventional) and Sigma XT (extinguishant) range of fire control panels, Syncro AS combines compact and practical styling with the programming power and connectivity normally associated with much larger systems.

Compatible Equipment & Extras



Selection of I/O boards

[See website](#)



Syncro Net Network Card

[See DS23](#)

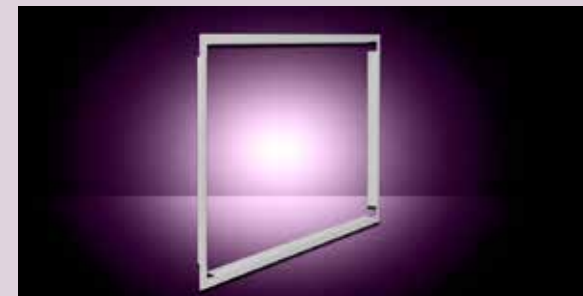

Flushing Collar

Syncro Repeaters

Analogue Addressable Fire Control Panel Repeaters



Syncro Ident

Syncro View

Syncro View Features

- Up to 15 annunciators can be connected to each Syncro or Syncro AS fire control panel.
- Large liquid crystal display (240 x 64 pixels)
- High brightness LED indications
- Internal sounder
- Replicates all Syncro panel controls
- Simple, two-wire serial connection
- Small, Syncro style enclosure
- Removable electronics for easy installation
- 24V DC or 230V AC power options
- Low power consumption
- Multi language options
- Connection monitored by Syncro AS fire control panel

Syncro View Overview

The Syncro VIEW fire alarm repeater provides a cost effective, simple and convenient method of extending the controls and indications of the Syncro AS fire alarm control panel to other locations.

The large, graphic LCD, brightness LED indicators and full set of controls duplicate the indications and controls on the Syncro AS fire alarm control panel at up to 15 additional locations via a (separate to the Syncro AS network) simple, two-wire serial data connection.

Ideal for locations where a control and indication point smaller than a full fire alarm control panel is required, the Syncro VIEW is available in either a 24V DC powered option (which can be powered via an additional 2 cores from the Syncro AS control panel auxiliary 24V DC supply) or a 230V powered option with local battery back up.

Syncro Ident Features

- 8 and 24 LED versions available as standard
- Large versions available to special order
- Up to 16 x 24 way Syncro Ident can be connected to each fire panel
- Programmable flashing or steady states
- Red, yellow or green indications/ options
- Common Fire, Fault and Disabled indication
- Customisable label identification tags
- Buzzer with silence control and re-sound
- Lamp test control
- Low power 24V DC supply
- Connects to 2 wire Syncro RS485 data bus
- Multiple language options

Syncro Ident Overview

Syncro Ident panels provide a compact and attractive display for up to 24 indications from a Syncro AS fire control panel.

As with all inputs and outputs on the Syncro AS system, each indicator is fully programmable to indicate a variety of events as well as being fully programmable via cause and effects to operate in response to logically connected inputs.

Each indication defaults to a zonal fire indicator but may be configured via the Loop Explorer configuration utility to operate upon any event type or combination of inputs.

Requiring only a low current 24V power supply and a 2 core data connection to the fire panel, Syncro Ident panels can be installed quickly and easily to provide supplementary information on the status of the fire alarm system with the minimum of cost and effort.



Syncro Matrix Features

- Up to 504 LED's can be controlled from any Syncro or Syncro AS panel
- Full colour printing
- Available in a range of standard enclosures to suit any applications
- Bespoke sized units can be made upon request
- Choice of Red, Green or Yellow LED's
- Available with or without controls
- Same look and feel as Syncro range
- Syncro Matrix can easily be upgraded on site with minimal cost and effort
- EN54-4 approved PSU (optional)
- Configured via standard Loop Explorer Software

Syncro Matrix Overview

Syncro Matrix is an innovative fire alarm mimic system which can be connected to any panel in the Syncro and Syncro AS fire alarm panel range.

The Syncro Matrix system uses flexible, fibre optic light guides to illuminate areas on a floor plan, laid over a high resolution grid. This unique system dispenses completely with wiring and enables indicators to be moved, removed or added on site without the need for any wiring.

Syncro Matrix can be supplied with or without common LEDs and controls. Optional LEDs indicate Power on, Fire, Fault and Disablement and optional controls are for Alarm silence, Buzzer silence, Lamp test and Reset.

Housed in attractive, slimline enclosures to match Syncro and Syncro AS fire alarm panels and with high quality, full colour or monochrome floor plans, Syncro Matrix provide a clear, geographical indication of fire alarm or other system activation enabling speedy identification of the source of an alarm or other event.

Configuration

The Syncro Matrix has a default configuration of zonal fire for the first 24 indicators but all indicators can be configured to operate upon any event type and at point, zone or group level via Kentec's powerful and intuitive Loop Explorer configuration programme.

Indicators may also be configured to flash or illuminate steadily upon activation. This flexibility allows Syncro Matrix mimics to be used for many other applications other than as a standard fire alarm indicator panel.

Future Proofing

The Syncro Matrix is ideal for buildings such as hospitals where the building layout may evolve over a period of time.

As the building changes, so too can Syncro Matrix, with very little cost or disruption. Modifying the mimic is very straightforward and can be carried out on site without the need for any wiring or special tools. The positions of the indicators can be freely moved anywhere on the grid and new indicators can be added using kits of lenses and light pipes which are available. Additional mimic PCB's are also available in kit form to enable the capacity of the mimic to be increased as required.

Custom Solutions

Where the requirements of the installation exceed the standard range of Syncro Matrix panels, completely bespoke solutions are available.

The enclosure size, mimic viewing area, colour and finish can all be tailored for the individual requirements of the site, including the option of surface or flush construction.

Up to 32 mimic PCB's can be connected to a single Syncro AS, Syncro or Syncro Response panel giving a total of 504 LED's that can be individually configured via the standard loop explorer configuration software.

To increase the flexibility of this product further, the LED extension boards are available in with yellow or green indicators fitted.

Enclosure Size Options

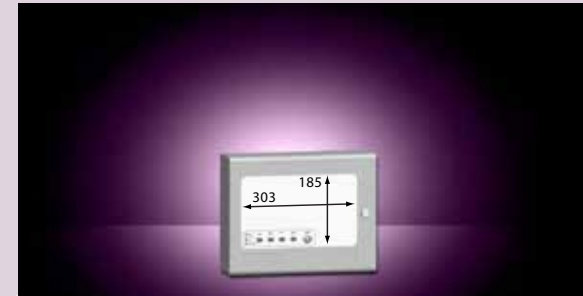

M2 385mm W x 310mm H x 90mm D

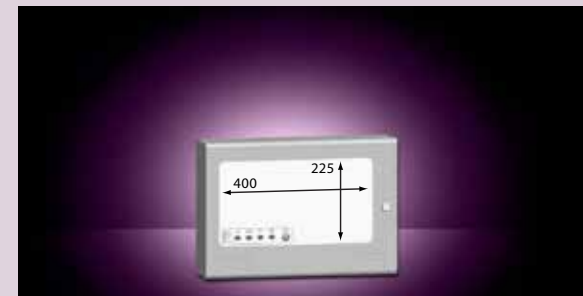

S3 500mm W x 355mm H x 117mm D



M3 385mm W x 520mm H x 110mm D

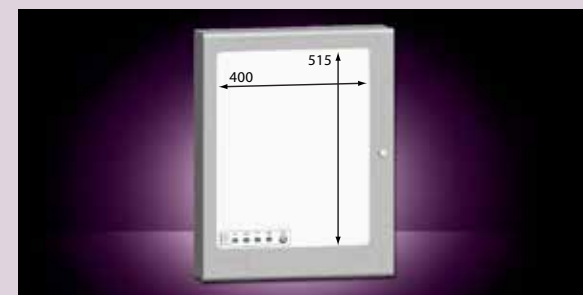

S4 500mm W x 650mm H x 137mm D

Syncro Network Diagram

High Integrity Configurable Network

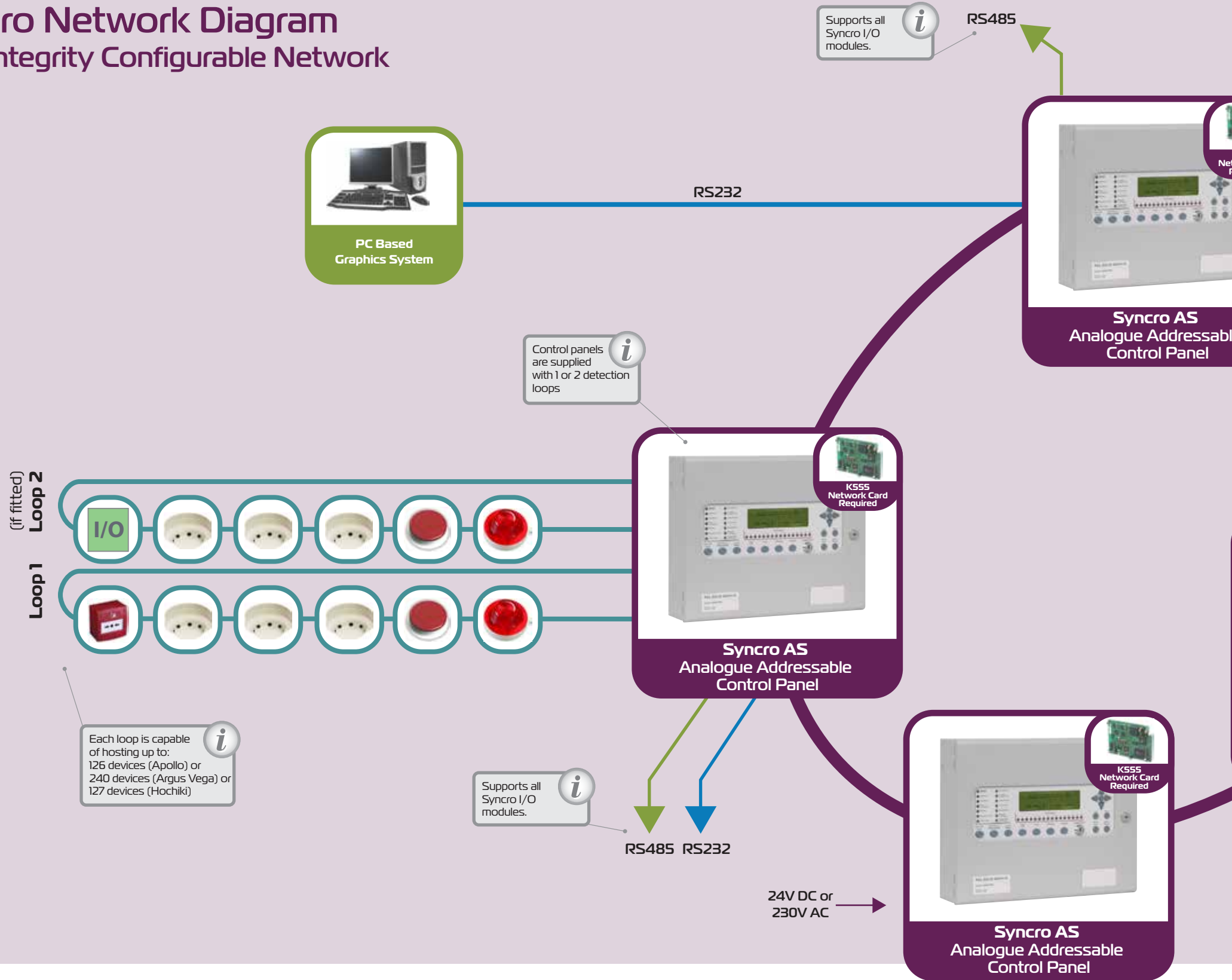

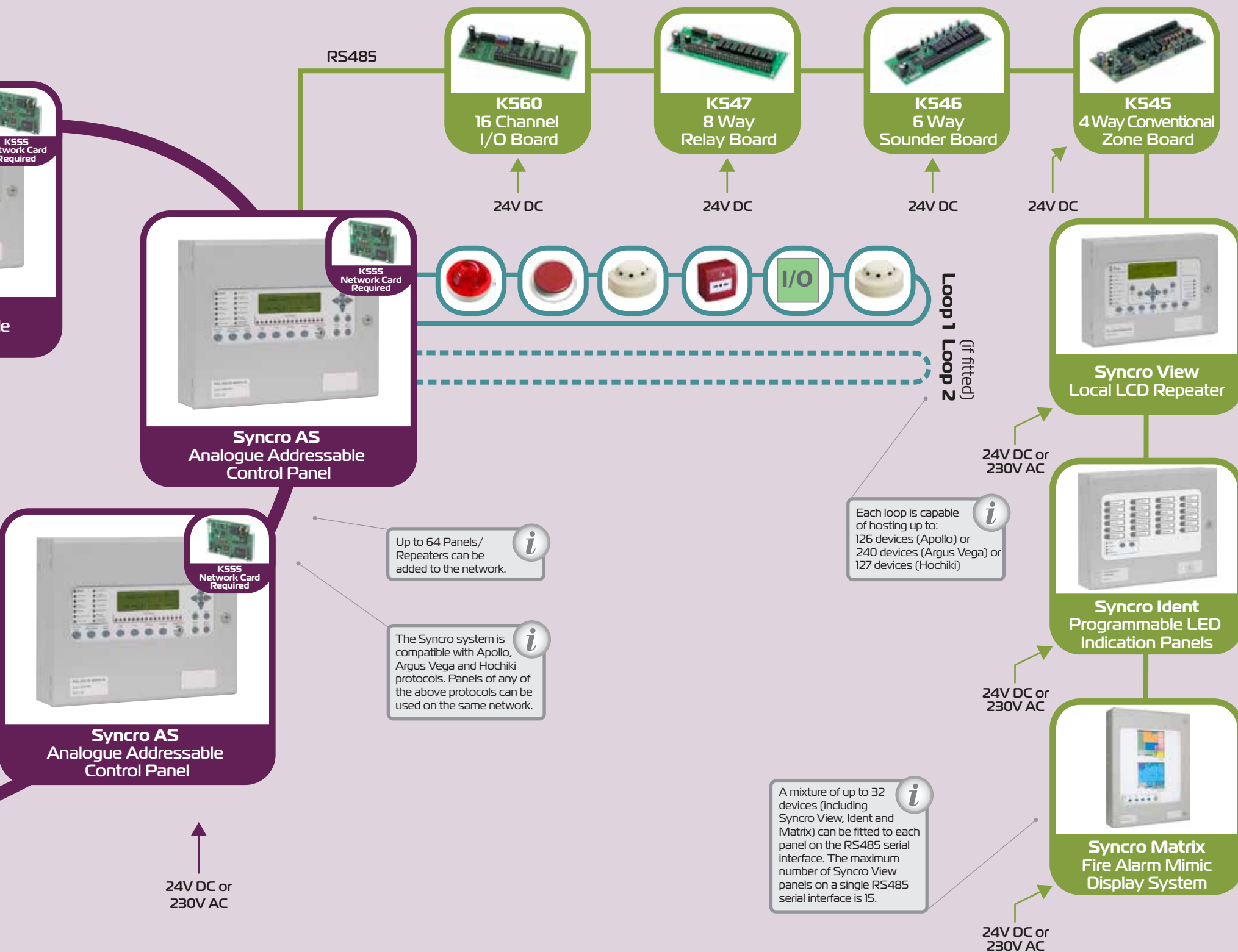



Sigma CP Features

- Fully certified to BS EN54-2 and BS EN54-4
- 2-wire and standard versions in 2, 4 or 8 zones
- Compatible for use on BS5839: Part 1: 2013 installations
- 2-wire repeaters and ancillary boards
- Fully programmable using simple menu options
 - Adjustable sounder delay time
 - Sounder configuration options
 - Zonal sounder delay detectors only
 - Zonal sounder delay call points only
 - Coincidence input selection
 - I.S Barrier selection by zone
 - Short circuit fire by zone
 - Non latching zones
 - Silent zones
 - Zone input delay
 - General panel configuration
- Simple, single board construction
- Installer friendly
- Compatible with wide range of detection devices
- Two monitored sounder outputs
- 3 Amp power supply
- Auxiliary power output

Sigma CP Overview

The Sigma CP range of conventional fire control panels are high specification, fully featured control units designed for the most demanding of conventional fire detection and alarm system applications.

Sigma CP is available with two, four or eight detection zones in standard or installation saving, "two wire" versions. The extensive range of configuration features available ensure suitability for new installations or panel replacements on older systems.

Configuration options are stored in non-volatile memory and are easily accessed via an intuitive user interface which allows the configuration data to be viewed and changed simply and easily.

Sigma CP control panels are compatible with most standard, conventional detectors, call points and sounders and are also compatible with "two wire" detector bases from Apollo and Hochiki.

An integral three Amp power supply and temperature compensated battery charger provides ample power for the two, 0.5 Amp rated standard sounder outputs, zonal sounder outputs on "two wire" versions and an auxiliary 24V supply output.

Powerful Features

The simple and intuitive programming interface on Sigma CP panels allows simple configuration of many parameters by entering simple codes which are listed on the inner door look up table and in the operation and maintenance manual. Configurable options include sounder delays, short circuit triggering of zones, non-latching zones, silent zones, I.S. barrier compatible zones and system disablements.

Connectivity

Sigma CP control panels have a dedicated; two wire serial bus for connection of repeater panels, Ancillary relay boards or zonal sounder extension boards. Up to seven units may be connected to the serial bus which can be up to 1200 metres in length. All units connected to the serial bus are fully monitored and the control panel will announce a fault condition showing the address and type of any units that fail or are disconnected after the panel has been configured to recognize them.

"Two wire" versions of Sigma CP can have detectors, call points and standard, polarized sounders connected to the same two core cable, greatly reducing installation time and cost on some installations.

These "two wire" versions also provide the capability of zonal sounders which may be configured as zonal alarm (sounders operate only in the zone of activation), common alarm (all sounders in all zones operate) or two-stage alarm (sounders are continuous in the zone of activation and pulsing in all other zones).

Ease of Installation

The elegant and simple construction of the panel enables the chassis to be completely dismantled by removing just two screws. The outer cover can also be detached by removing two hinge pins making first fix installation very simple and enabling the sensitive electronic parts to be stored safely for re-fitting at the commissioning stage.

Sigma CP panels combine compact and practical styling with the programming power and connectivity required for the most complex and demanding conventional fire alarm system installations.

Compatible Equipment & Extras



Sigma CP-R Repeater Panel

See DS39



Sigma CP Ancillary PCB

See page 39



Sigma Sounder - Sounder Controller Units

See DS48



Flushing Collar

Sigma CP-A

AlarmSense

Conventional Fire Alarm Control Panels AlarmSense Compatible 2-wire



Sigma CP-A Features

- Fully compliant with BS EN54-2 and BS EN54-4
- Allows systems to be installed in accordance with BS5838: Part 6
- 2 wire systems, reduces installation cabling
- 2-wire repeaters and ancillary boards via serial bus
- Fully programmable using simple menu options
- Adjustable sounder delay time
- Sounder configuration options
- Zonal sounder delay for detectors only
- Zonal sounder delay for call points only
- Coincidence output via ancillary board
- Short circuit fire selectable by zone
- Non latching selection by zone
- Silent zones (common sounder outputs)
- Zone input delay for sprinkler system connection
- AlarmSense® local alarm feature supported
- Simple, single board construction
- Installer friendly
- Compatible with all AlarmSense® devices
- Two conventional monitored sounder outputs
- 3 Amp power supply
- Auxiliary power output

Sigma CP-A Overview

The Sigma CP-A AlarmSense® range consists of a series of conventional, 2, 4 and 8 zone fire alarm control panels.

The AlarmSense® system enables all detection and sounder devices in a given zone to be wired to the same pair of cables thus greatly reducing the cabling and installation requirements and hence costs.

The AlarmSense® range of devices includes smoke and heat detectors, call points, base sounders, base sounder/beacons and relay units – all wired to the same pair of cables.

Having sounders and sounder beacons installed on the same cabling as detectors and call points allows all systems to be configured for common, zonal or two stage alarm by simply setting one of the panels configuration options.

Selection of the AlarmSense® local alarm feature at sounder or sounder beacon bases invokes the alarm verification feature. This is particularly useful in Houses of Multiple Occupation such as student accommodation or nursing homes. When sounder or sounder beacon bases are selected for local alarm mode, alarms are restricted such that only the sounder connected to the activated detector will operate initially. The panel will attempt to reset the activated detector after a time delay and if successful no further alarms are sounded. If the detector re-activates after being reset, a general alarm will sound throughout the premises.

Activation of a second detector or a call point will sound the general alarm immediately.

The alarm verification feature of the Sigma CP-A control panel greatly reduces the risk of unwanted alarms or call outs while still providing secure, high quality fire protection throughout the premises.

All control panels have an integral, 3 Amp mains powered battery charger and power supply capable of providing power to the most demanding of applications.

Ease of Installation

The elegant and simple construction of the panel enables the chassis to be completely dismantled by removing just two screws. The outer cover can also be detached by removing two hinge pins making first fix installation very simple and enabling the sensitive electronic parts to be stored safely for re-fitting at the commissioning stage.

Compatible Equipment & Extras



Sigma CP-R Repeater Panel

See DS39



Sigma CP Ancillary PCB

See page 39



Sigma Sounder - Sounder Controller Units

See DS48



Flushing Collar

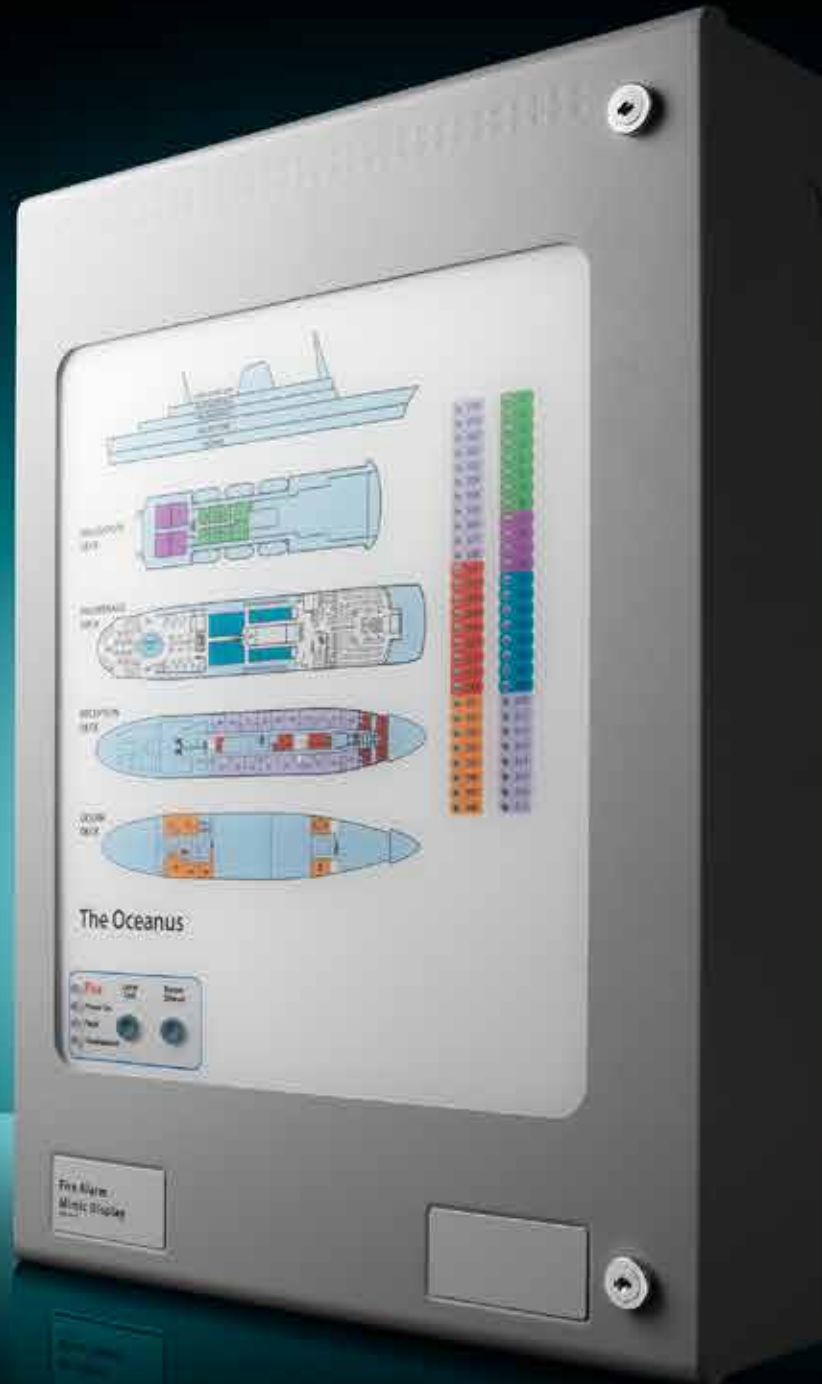

Sigma Matrix Features

- Up to 320 LED's can be controlled
- Full colour printing
- Available in a range of standard enclosures to suit any application
- Bespoke sized units can be made upon request
- Choice of Red, Green or Yellow LED's
- Available with or without controls
- Same look and feel as Sigma range
- Sigma Matrix can easily be upgraded on site with minimal cost and effort
- EN54-4 approved PSU (optional)

Sigma Matrix Overview

Sigma Matrix is an innovative fire alarm mimic system which can be connected to any system providing volt free contacts or a switched 24V DC supply.

The Sigma Matrix system uses flexible, fibre optic light guides to illuminate areas on a floor plan, laid over a high resolution grid. This unique system dispenses completely with wiring and enables indicators to be moved, removed or added on site without the need for any wiring.

Sigma Matrix can be supplied with or without common LEDs and controls. Optional LEDs indicate Power on, Fire, Fault and Disablement and optional controls are for Alarm silence, Buzzer silence, Lamp test and Reset.

Housed in attractive, slimline enclosures to match and with high quality, full colour or monochrome floor plans, Sigma Matrix provides a clear, geographical indication of fire alarm or other system activation enabling speedy identification of the source of an alarm or other event.

Future Proofing

The Sigma Matrix is ideal for buildings such as hospitals where the building layout may evolve over a period of time.

As the building changes, so too can Sigma Matrix, with very little cost or disruption. Modifying the mimic is very straightforward and can be carried out on site without the need for any wiring or special tools. The positions of the indicators can be freely moved anywhere on the grid and new indicators can be added using kits of lenses and light pipes which are available. Additional mimic PCB's are also available in kit form to enable the capacity of the mimic to be increased as required.

Custom Solutions

Where the requirements of the installation exceed the standard range of Sigma Matrix panels, completely bespoke solutions are available.

The enclosure size, mimic viewing area, colour and finish can all be tailored for the individual requirements of the site, including the option of surface or flush construction.

Standard Enclosure Size Options

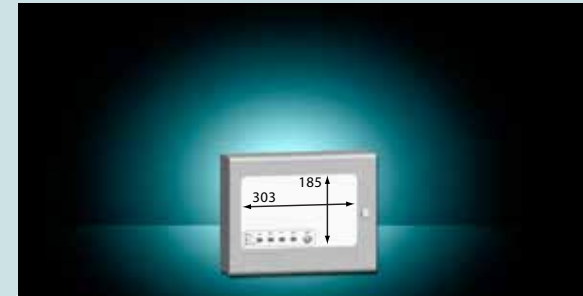

M2 385mm W x 310mm H x 90mm D

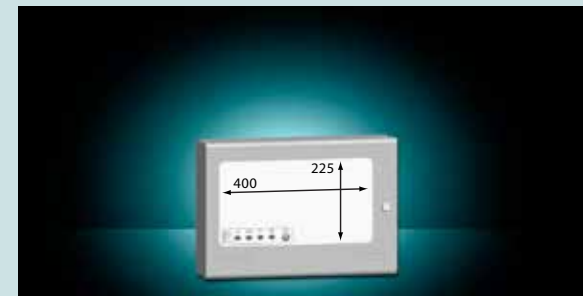

S3 500mm W x 355mm H x 117mm D



M3 385mm W x 520mm H x 110mm D

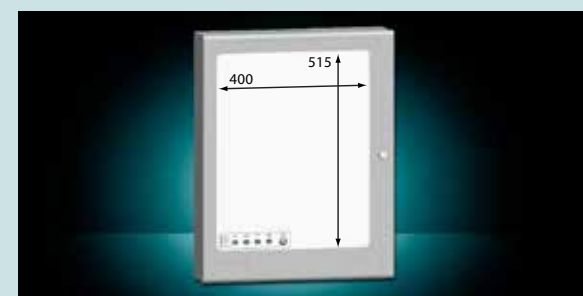

S4 500mm W x 650mm H x 137mm D

Sigma CP Network Diagram

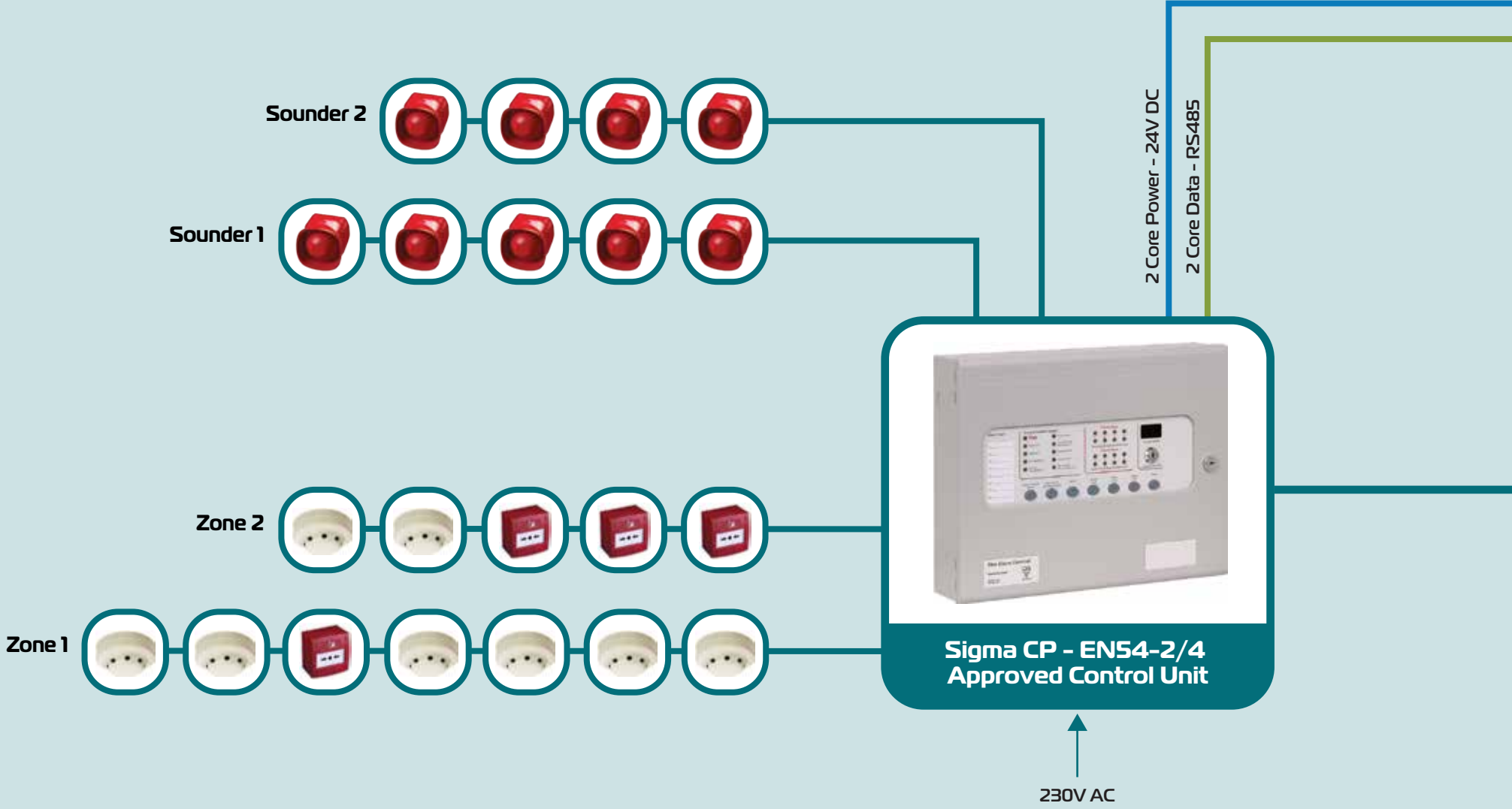

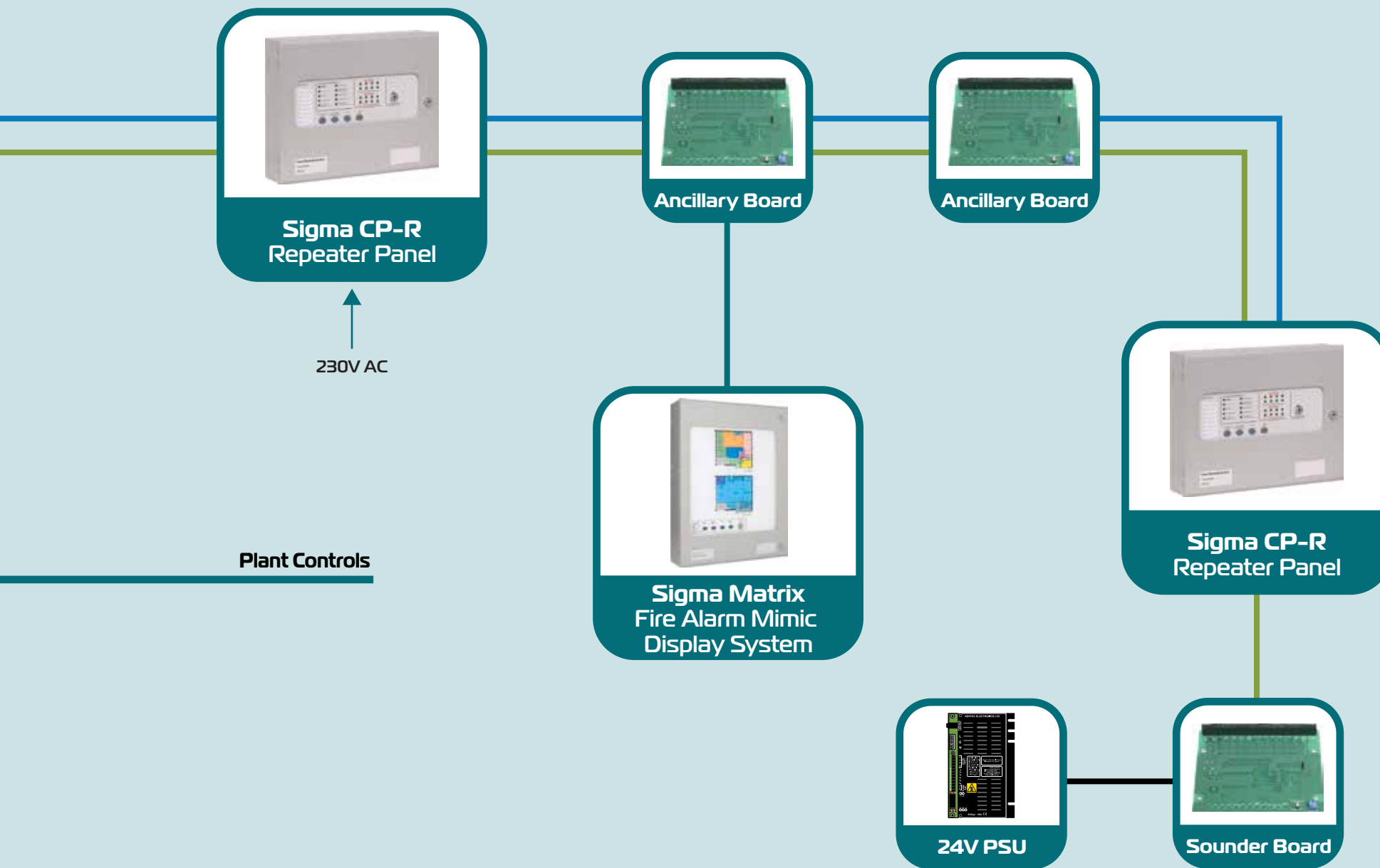



Sigma XT Features

- Approved to EN12094-1, EN54-2 and EN54-4
- Three detection zones as standard
- Any single zone or any combinations of zones can be configured to release
- Configurable first stage sounder delays
- Configurable detection delays
- Zero time delay upon manual release option
- Compatible with I.S. barriers
- Non-latching zone input option to receive signals from other systems such as aspirating equipment
- Configurable extinguishant delays up to 60 seconds in 5 second steps
- Configurable extinguishant duration up to 5 minutes in 5 second steps
- Countdown timer shows time remaining until release
- Supports up to seven, four wire status indicators
- Built in Extract Fan control

Sigma XT Overview

Designed and manufactured to the highest standards in a quality controlled environment, the Sigma XT extinguishant releasing panel offers outstanding value and performance for all small to medium fixed firefighting installations.

With three detection zones as standard, extinguishant release can be configured to activate from any combination of detection zone inputs to allow (among other combinations) any two from three type activations such as would be required for detection in ceiling void, room and floor void applications.

The extensive configuration options of the Sigma XT allow the functionality of the system to be extensively modified while still complying with the requirements of the controlling standards for the equipment.

The panel contains a large LED display to enable easy configuration and control which also displays the time remaining until extinguishant release for added user safety.

The countdown timer is duplicated on up to seven remote status units to provide local indication of the extinguishant system status. With all of the electronics mounted on a single, easily removable, steel plate Sigma XT panels are both robust and easy to install.

Connectivity

To compliment the Sigma XT control panel there is a range of system status units.

Up to seven status units can be connected on a serial bus and require just two cores for data and two cores for power. Once connected, status units are supervised and the Sigma XT control panel will indicate a fault condition should any unit become disconnected.

Ease of Installation

The elegant and simple construction of the panel enables the chassis to be completely dismantled by removing just two screws. The outer cover can also be detached by removing two hinge pins making first fix installation very simple and enabling the sensitive electronic parts to be stored safely for re-fitting at the commissioning stage.

Compatible Equipment & Extras



Sigma Si Status Units

See DS41



Hold Off & Extinguishant Abort Switch

See DS86



Extinguishant Keyswitches

See DS86



Sigma Si Ancillary PCB

See DS75

Sigma XT+

Extinguishant Control Panel Multi-Area

Sigma XT+ Features

- Approved to EN12094-1, EN54-2 and EN54-4
- 2, 4 or 8 detection zones
- 1 to 4 extinguishant areas
- Dual extinguishant outputs for each area (configurable as Main/Reserve)
- First and second stage sounder outputs for each area
- First and second stage volt free changeover contacts for each area
- Released volt free contact per area
- Fault volt free contact per area
- Programmable extinguishant delays
- Programmable output duration
- Extract fan control
- Countdown indicator shows time until release in seconds
- Mode select and manual release controls per area
- Monitored remote manual release input
- Monitored remote Hold input
- Monitored remote Mode select (door interlock) input
- Monitored remote Released pressure switch input
- Monitored remote Low Pressure switch input
- Monitored Abort input
- Serial connection for Sigma SI status units and ancillary boards. (K588)



Sigma XT+ Overview

The Sigma XT+ range combines feature rich, Sigma CP conventional fire detection from two to eight zones with highly configurable extinguishing control modules to provide an integrated control solution for extinguishing systems with up to four protected areas.

The fire detection section connects to the extinguishant control modules via a serial link which allows secure, bi-directional transfer of data between the two. Sigma XT+ modules may be mounted remotely in separate enclosures and connected to Sigma CP panels via this serial interface to provide central fire detection and control with distributed extinguishing systems.

Sigma XT+ modules may also be mounted separately from fire detection and control equipment and activated by addressable output modules or volt free contacts from other systems via two monitored activation inputs.

The fire detection part of the system has all of the benefits of the popular Sigma CP range with its many, easily accessed configuration options and compatibility with a wide range of detection devices.

The Sigma XT+ extinguishing modules set a new benchmark for extinguishing control panels. Each module is controlled by its own powerful microcontroller bringing unparalleled intelligence and versatility to multi area extinguishing systems for the first time.

Sigma XT+ modules have inputs and outputs to cover all system requirements including individual, monitored first and second stage alarms and dual extinguishing outputs. The extinguishing outputs can be configured to operate together or as main and reserve for essential back up following a discharge. They can also be individually calibrated to provide true open and short circuit monitoring through pyrotechnic actuators or a wide range of solenoids.

Connectivity

In addition to Sigma XT+ extinguishing modules, up to seven Sigma CP ancillary boards providing zonal and common relay outputs and seven Sigma CP sounder boards, each providing an additional eight, monitored sounder circuits can be connected to the Sigma CP RS485 serial bus at up to 1200 metres from the control equipment.

Also, up to seven Sigma XT ancillary boards and seven Sigma Si status units can be connected to each Sigma XT+ module to provide remote status indication, control and additional outputs as required at up to 1200 metres from the control equipment. This flexibility ensures that any system configuration can be realised with a minimum of cabling.

Ease of Installation

The simple construction of Sigma XT+ control panels utilises removable bridge plates for mounting all electronic assemblies. These bridge plates bring the terminals to the front of the enclosure providing easy access to all wiring terminals.

The outer door may be removed to further improve access by withdrawing the easily accessible hinge pins. This ensures clear access for wiring and protection of the electronic assemblies during installation.

Multiple knockouts in the top, bottom and back and sides of the enclosures provide ample options for cable entries.

Compatible Equipment & Extras



Sigma Si Status Units

See DS41



Hold Off & Extinguishant Abort Switch

See DS86



Extinguishant Keyswitches

See DS86



Sigma Si Ancillary PCB

See DS75



Sigma Si Features

- Approved to EN12094-1, EN54-2 and EN54-4
- 2, 4 or 8 detection zones
- Certified compliant with BS EN12094-1 when used with Sigma XT control equipment
- High brightness LEDs
- Detailed indication of the status of the control panel
- Monitored data connection
- Countdown timer shows time remaining until release
- Manual only and Automatic & Manual mode select keyswitch option
- Four wire connection (data and power)
- Protected dual action manual release switch option
- Option for zonal fire and common fault indication with buzzer
- Robust, high quality enclosure
- Easy access to terminals
- Remote Auto/Manual door interlock input (monitored)
- Remote Hold input (monitored)
- Internal fault diagnosis indicators
- Weatherproof IP65 versions available
- Internal buzzer

Ancillary PCB Features

- Two wire serial connection
- Up to 7 per system
- 230V AC or 24V DC powered versions
- Volt free relay outputs for fire and extinguishing system status
- Relay operated LED indicators

Sigma Si Overview

Sigma Si is range of system status indicator units for use with Kentec Sigma XT and Sigma XT+ extinguishant releasing control panels.

The Sigma Si range of status indicators provide detailed status information for Sigma XT and Sigma XT+ extinguishant release control equipment.

All models provide high brightness, LED indication of Manual Only, Automatic and Manual, Hold operated, Disabled, Imminent and Released conditions. Models are also available with zonal fire indicators and a common fault indicator.

For systems where local control of the Automatic/ Manual mode and or a Manual extinguishant release control are required, units are available with these controls fitted.

All models have monitored inputs for the remote connection of Automatic/ Manual mode and Hold switches and are provided with a large, LED display which shows a countdown of the time remaining until the extinguishant is released in seconds.

Hold Off Overview

Sigma Si Hold off units are available with red or green actuators (BS 7273-1 recommends white with red button) and are mounted in a single gang, surface mounting enclosure. For flush mounting, the enclosure may be discarded and the unit mounted to a standard UK single gang electrical back box..

The unit has a durable, shrouded push button to prevent accidental operation and a simple 2 wire connection to Sigma XT, Sigma XT+ or Sigma Si status units is required.

Sigma Si Hold off units are fitted with normally open and normally closed contacts to allow operation with monitored and unmonitored systems

Ancillary PCB Overview

The Sigma XT Ancillary PCB is compatible with Sigma XT and Sigma XT+ control panels.

The board provides volt free normally open contacts allowing control of sub-systems and plant remotely from the main panel over a two wire data bus.

Mains powered, boxed Ancillary boards require only a two core data cable from the main control panel.

24V DC versions require an additional two cores for power either from the main panel or from another 24V DC source.

Up to 7 Ancillary boards can be connected to a control panel and each is allocated an address from 1 to 7 using a binary coded DIL switch. The total length of the data cable from the main panel to the last repeater can be up to 1200 metres.

A mixture of status units and Ancillary boards, up to a maximum of 7 of each type, can be connected to the serial data bus.

Syncro XT+

Extinguishant Control Panel Multi-Area Addressable



Syncro XT+ Features

- Complies with EN12094-1, EN54-2 and EN54-4
- 16 detection zones
- Up to 4 extinguishant areas
- Dual extinguishant outputs for each area (configurable as Main/Reserve)
- First and second stage sounder outputs for each area
- First and second stage volt free changeover contacts for each area
- Released volt free contact per area
- Fault volt free contact per area
- Programmable extinguishant delays
- Programmable output duration
- Countdown indicator shows time until release in seconds
- Mode select and manual release controls per area
- Monitored remote manual release input
- Monitored remote hold input
- Monitored remote mode select (door interlock) input
- Monitored remote released pressure switch input
- Monitored Abort input
- Serial connections for Sigma Si status units and ancillary boards. (K588)

Syncro XT+ Overview

Syncro XT+ control panels are multi-area extinguishant control panels complying with EN12094-1, EN54-2 and EN54-4.

Up to 16 zones of addressable detection over 1 or 2 loops ensure every detector is able to contribute to extinguishant release.

Up to 4 extinguishing areas and 2 releasing outputs per area can be controlled via simple coincidence detection or via more complex cause and effects configured by the Loop Explorer configuration programme.

Syncro XT+ allows extinguishing systems to take full advantage of the more sophisticated detection techniques provided by modern fire detectors as well as the other benefits of analogue addressable systems such as control of loop connected sounders, beacons and input/output modules.

With the addition of a Syncro network card, Syncro XT+ control panels can be networked to provide scalable extinguishing systems for all sizes of installation.

Stand alone extinguishant control units are also available with 2 monitored inputs to receive initiating signals from remote fire detection control panels or addressable modules.

Each extinguishant area has a comprehensive set of inputs and outputs and is configurable via the Loop Explorer Configuration Programme.

All extinguishant areas may have up to 7, serially connected Sigma Si status indication and control units or ancillary relay boards connected via a simple 4 core cable.

Compatible Equipment & Extras



Sigma Si Status Units

See DS41



Syncro Si Status Units

See DS79



Hold Off & Extinguishant Abort Switch

See DS86



Extinguishant Keyswitches

See DS86

Sigma XT Network Diagram

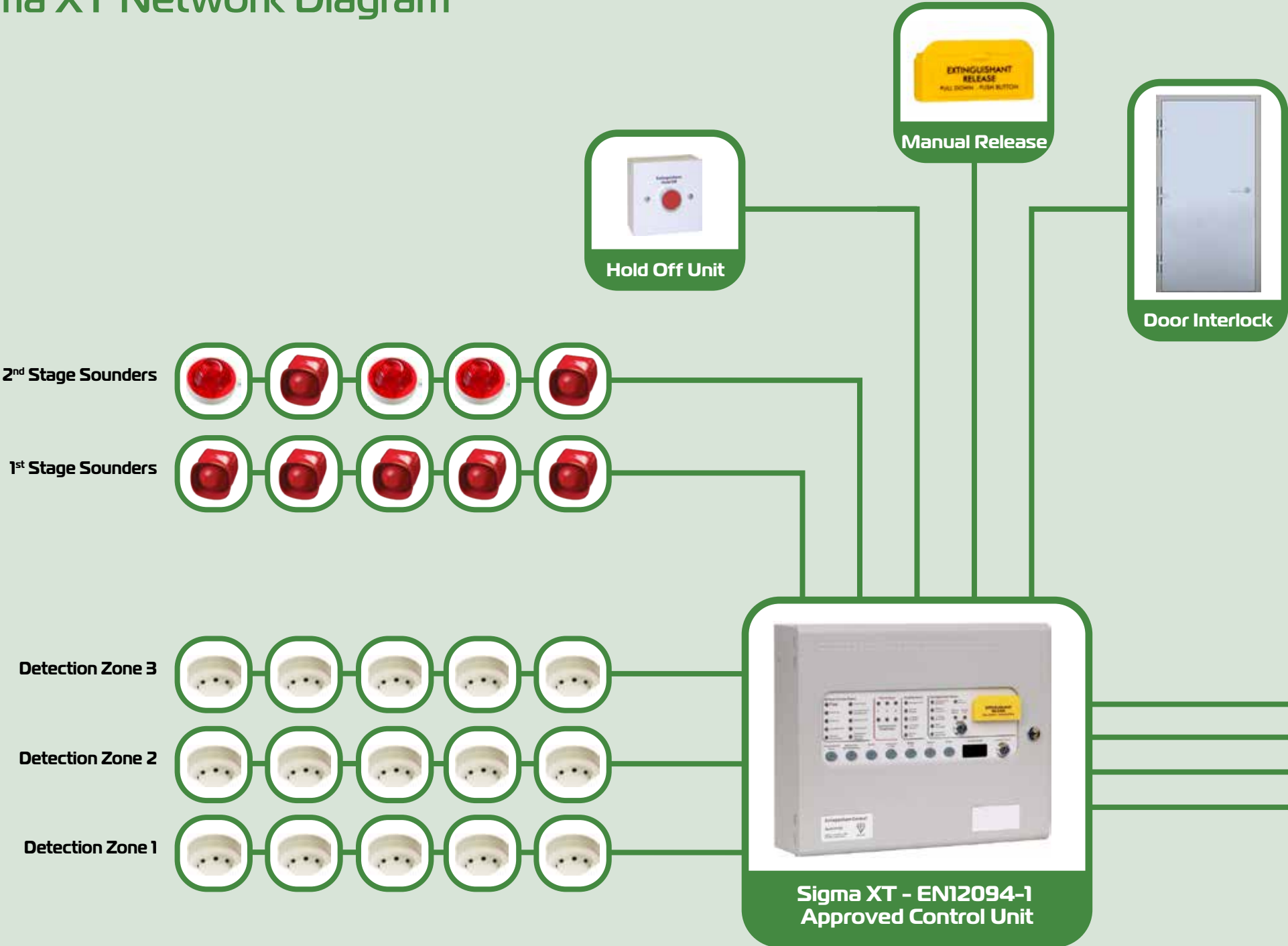

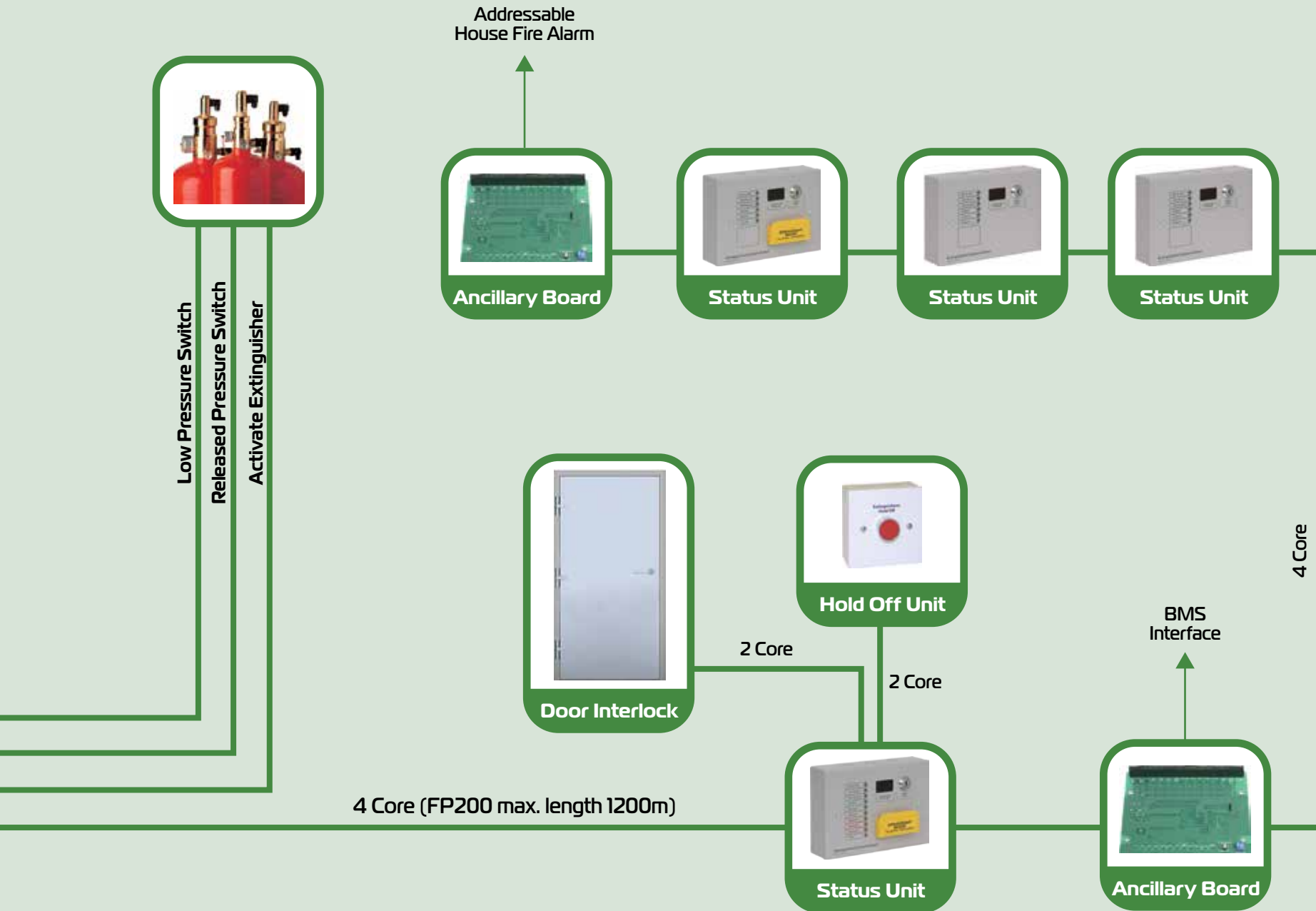



S408

S406

S2014

K25000 Power supplies Overview

The K25000 range of 24V DC power supplies are designed to meet the exacting requirements of fire detection and alarm systems and fire protection systems.

All models charge sealed lead acid batteries using sophisticated, temperature compensated charging and monitoring techniques to keep the batteries in the best possible condition.

Over depletion of batteries is prevented by a low battery voltage disconnection function which removes the load from the batteries when their terminal voltage reduces to a level which would damage them.

A low battery voltage fault warning is given when the batteries reach the minimum terminal voltage recommended by the battery manufacturers.

A high series resistance in the battery supply circuit which would allow the power supply output voltage to fall outside of the specified range is indicated as a fault condition.

K25000 power supplies can be fitted with an optional dual output board to provide redundant power paths for fire alarm applications and are available in a range of enclosures to accommodate different battery sizes.

Onboard LED indicators are provided to indicate the status of the unit and an onboard header is available to extend status signals to other systems volt free relay contact that operates upon any fault condition or total power failure.

Enclosures are designed to match both Sigma and Syncro fire panel ranges and are constructed from 1.2mm mild steel and are finished with epoxy powder coating.

The K25000 boxed range is available in the following power outputs:

K25250 range – 2.5A output and up to 12Ah batteries

K25400 range – 5.25A output and up to 26Ah batteries

K25800 range – 10.25A output and up to 45Ah batteries

Unboxed or caged power supplies for incorporation into other equipment are available as follows:

S2014 – 2.6A output

COMING SOON

S406- 5.25A output

S408 – 10.25A output

Power Supply Units



S2014 - 2.6A PSU



S406 - 5.25A PSU

See DS19



S408 - 10.25A PSU EN Approved

See DS67



10.25A PSU UL Approved

See DS91

Miscellaneous Items



Warning Signs

Remote Indicator Unit

DocBox

Audio Visual

1Way Relay Board

Remote Indicator Unit

4Way Relay Board

Tamper Resistant Vision Window

Warning Signs

Powered by a nominal 24V DC supply, the illuminated warning signs employ the very latest in LED technology to provide a high reliability, high brightness, audio/ visual warning indication unit to supplement mandatory alarm warnings.

The brightness of the sign remains constant over its entire operating range of 15 to 30 volts DC due to the unique "power boost" circuitry employed. This ensures that even with a system running on depleted batteries, all signs remain at full intensity.

A range of standard text signs are available and fully customised text and languages are easily accommodated. The large display panel is backlight with high intensity white LEDs to provide a high contrast indication in a range of different colours.

A split level function allows the top and bottom halves of the sign to be illuminated independently via separate inputs or by reversing the supply voltage allowing two stage messages to be displayed if required.

The internal buzzer can be enabled or disabled via configuration switches and it can be silenced via a two wire remote input.

The enclosure is slimline and attractively finished in a durable, neutral epoxy powder coat.

Tamper Vision Resistant Window

The Tamper Resistant Vision Window is perfect for public areas where restricted access is necessary to prevent damage and unauthorised operation of the control panel. The cover features a fully welded steel construction and key lockable inner door making it robust and secure.

The Vision Window is available from stock, fully assembled, and can be fitted on site in minutes by simply taking out the hinge pins on the existing enclosure and removing the lid before fitting the new Vision Window cover and hinge pins.

Control panels can also be supplied pre-fitted with the Vision Window on any M2, H2, M3, and H3 size control panels.

Sigma DocBox

Designed to provide a convenient method of storing system test records, manuals, configuration files, keys and other documents or access arrangements for fire alarm and protection systems, the Sigma DocBox is finished and constructed in a similar manner to Sigma and Syncro fire alarm control equipment.

Available as standard, deep or extra deep versions, DocBoxes are available to suit any size of installation.

The DocBox also doubles up as a Key Box providing 7 easily accessible formed key hooks inside the enclosure and is itself lockable using a standard fire control panel key.

Relay Boards

Easy to fit and wire for additional control functions or to expand the capability of existing relay outputs, these simple boards contains either one or four 24V DC relays, which can be used for any extra low voltage switching applications.

Each relay has two changeover contacts, and an LED indicator to show when the coil is energised.

The coils of the relays are commoned to the positive supply and the relays can be operated individually by switching a negative to the numbered coil inputs.

The contacts are suitable for switching a maximum of 30V DC and 2 Amps. The current consumption of the unit when operated from a 24V supply is approximately 25mA per relay.

Audio Visual

A range of indicator units with either red or yellow indicators to provide audible and visual status of alarms, isolations or other functions.

These units are available with a keyswitch to silence the internal buzzer or a keyswitch to illuminate the indicator and buzzer. A volt free contact is provided when the keyswitch is operated for ancillary control functions.

The units are mounted in a durable steel enclosure that has the same plate fixing centres as a standard UK single gang electrical box allowing the unit to be easily flush mounted if required.

Remote Indicator Unit

Remote indicator units provide an extension for LED indicators on hidden detection devices to allow their status to be observed without having to expose the detection device itself.

All units have dual, high brightness LED indicators with a wide viewing angle that flash alternately to attract attention and are available mounted to square or round metal plates for fitting to standard electrical back boxes. They are finished in white, durable epoxy powder and printed in red with "FIRE ALARM IN CONCEALED SPACE". Other printing options are available upon request.

Remote indicators are compatible with all types of conventional and addressable detectors.

Elite

Analogue Addressable Fire Control Panels & Repeaters
UL/ FM Approved



Elite RS

Elite RS is a versatile range of open protocol fire alarm control panels compatible with existing Elite fire alarm panel technology.

Available with one or two detection loops capable of hosting up to 500 devices.

Elite RS uses leading edge microprocessor based electronics to provide a flexible control system with high reliability and integrity.

Suitable for all small to medium sized fire detection systems, Elite RS control panels can be expanded and networked to become part of much larger systems if the need arises, therefore providing a future proof solution for any installation.

With its large graphical display and ergonomic button and indicator layout, the Elite RS control panel is simple and straightforward to understand for installers, commissioning engineers and end users alike.

eMatrix

The eMatrix system uses flexible, optic light guides to illuminate areas on a floor plan, laid over a high resolution grid. This unique system dispenses completely with wiring and enables indicators to be moved, removed or added on site without the need for any wiring.

All indicators can be configured to operate upon any event type and at point, zone or group level via the powerful and intuitive Loop Explorer configuration or ESP Discovery. eMatrix can be supplied with or without LEDs and controls. Optional LEDs indicate Power on, Fire, Trouble and Disablement and optional controls are for Alarm silence, Buzzer silence, Lamp test and Reset.

Housed in attractive, slimline enclosures to match Elite fire alarm panels and with high quality, full colour or monochrome floor plans, eMatrix provides a clear, geographical indication of fire alarm activation enabling speedy identification of the source of an alarm.

eView

Designed and manufactured to the highest standards in a quality controlled environment the eView fire alarm annunciator provides a simple and convenient method of extending the controls and indications of the Elite fire alarm control panel to other locations.

The large, graphic liquid crystal display and high brightness LED indicators duplicate the indications on the Elite fire alarm control panel at up to 15 additional locations via a simple, two-wire serial data connection.

The eView is powered by 24V DC (which can be via an additional 2 conductors from the control panel or local 24V DC listed supply).

eView is housed in a small enclosure which is styled similarly to the Elite control panel and is ideal for installations where a large control panel would be detrimental to décor such as entrance halls.

Up to 15 eView annunciators can be connected to each control panel on the Elite network making eView ideal where multiple points of indication and/ or control are required such as nurses stations or shop units.

Sigma A-CP

Conventional Control Panel
UL Approved



Sigma A-CP Features

- UL864 approved
- Two, four or eight initiating circuits
- Initiating circuits individually configurable as Fire, Water flow or Supervisory
- Two 2A notification appliance circuits
- Selectable NAC sync protocols
- Two 2.0A notification appliance circuits
- 6.5A power supply
- Alarm verification selectable by zone
- Resettable Aux power output rated at 0.3A
- Aux power configurable to power off on Fire condition
- Fire, Trouble and Supervisory relays
- Single person walk test function
- Optional DACT
- Many advanced configuration options
- 72 hour standby with 7Ah batteries
- Compact enclosure

Sigma A-CP Overview

The Sigma A-CP is a range of conventional fire control panels with optional built in communicator.

With 2, 4 or 8 initiating circuits all panels can be extensively configured via a simple front panel operated programming method.

The low standby power requirements and cost effective small batteries allow the panel to be mounted in a small discrete enclosure which is available in standard red or optionally in an attractive grey colour.

A simple programming method using just 3 front panel buttons allows an extensive list of configuration options to be set and reviewed.

Single board construction which allows easy removal of all electronic parts by removing just 2 screws and ample provision of cable entry knockouts simplify installation.

4 Amp notification appliance power and built in selectable sync protocols provide ample power and control for a wide range of standard notification appliances.

The built in RS485 communications bus provides the facility to connect 4 wire annunciators or ancillary relay boards to provide further indication and control options throughout a premises.

The optional DACT allows dual line reporting to central stations and provides a 500 event history buffer.

Compatible Equipment & Extras



Sigma A-CP Ancillary Board

See DS78



Sigma A-CP Annunciator

See DS93



Sigma A-CP available in grey

See DS78

Sigma A-XT

Extinguishant Control Panel UL/ FM Approved



Sigma A-XT Features

- UL854 and FM listed
- Three initiation circuits as standard
- Any single zone or any combinations of zones can be configured to release
- Configurable first stage NAC delays
- Configurable detection delays
- Zero time delay upon manual release option
- Compatible with I.S. barriers
- Non-latching zone input option to receive signals from other systems such as aspirating equipment
- Configurable releasing delays up to 60 seconds in 5 second steps
- Configurable releasing duration up to 5 minutes in 5 second steps
- Countdown timer shows time remaining until release
- Supports up to seven, four wire status indicators
- Built in Extract Fan control

Sigma A-XT Overview

Designed and manufactured to the highest standards in a quality controlled environment and with UL and FM approvals, the Sigma A-XT releasing panel offers outstanding value and performance for all small to medium fixed firefighting installations.

With three initiation circuits as standard, release can be configured to activate from any combination of detection zone inputs to allow (among other combinations) any two from three type activations such as would be required for detection in ceiling void, room and floor void applications.

The extensive configuration options of the Sigma A-XT allow the functionality of the system to be extensively modified.

The panel contains a large LED display to enable easy configuration and control which also displays the time remaining until release for added user safety.

The countdown timer is duplicated on up to seven remote status units to provide local indication of the system status.

With all of the electronics mounted on a single, easily removable, steel plate Sigma A-XT panels are both robust and easy to install.

Sigma A-XT is supplied in an enclosure that matches the design and colour of the Elite RS range and is available in standard red or optional grey.

Compatible Equipment & Extras



Sigma A-Si Status Units

See DS73



Sigma A-Si Hold Off Switch

See DS73



Sigma A-Si Disabling Switch

See DS73



Sigma A-Si Ancillary PCB

See DS74



Sigma A-Si Features

- UL854 and FM listed
- High brightness LEDs
- Detailed indication of the status of the control panel
- Supervised data connection
- Countdown timer shows time remaining until release
- Manual only and Automatic & Manual mode select keyswitch option
- Four wire connection (data and power)
- Protected dual action manual release switch option
- Option for zonal fire and trouble indication with buzzer
- Robust, high quality enclosure
- Easy access to terminals
- Remote Auto/Manual door interlock input (supervised)
- Remote Abort input (supervised)
- Internal trouble diagnosis indicators

Ancillary PCB Features

- UL854 and FM listed
- Two wire serial connection
- Up to 7 per system
- Volt free relay outputs for fire and releasing system status
- Relay operated LED indicators

Sigma A-Si Overview

The Sigma A-Si range of status indicators provide detailed status information for Sigma A-XT releasing control equipment.

All models provide high brightness, LED indication of Manual Only, Automatic and Manual, Abort operated, Disabled, Imminent and Released conditions. Models are also available with zonal fire indicators and a common trouble indicator.

For systems where local control of the Automatic/ Manual mode and or a Manual extinguishant release control are required, units are available with these controls fitted.

All models have supervised inputs for the remote connection of Automatic/ Manual mode and abort switches.

All units contain a large, LED display which shows a countdown of the time remaining until release in seconds.

Connectivity

Up to seven Sigma A-Si status units can be connected to the Sigma A-XT serial bus and require just two cores for data and two cores for power.

Once connected, status units are supervised and the Sigma A-XT control panel will indicate a fault condition should any unit become disconnected.

Hold Off Overview

The Sigma A-Si Abort switch connects to the Abort terminals of the Sigma A-XT releasing panel. Any number of Sigma A-Si Abort switches may be connected to the circuit.

The last switch must have the end of line device from the Abort circuit terminals of the Sigma A-XT releasing panel fitted across its connections to provide open and short circuit supervision.

The unit is supplied mounted to a rugged steel enclosure but may also be flush mounted to a single gang electrical box.

Ancillary PCB Overview

The Sigma A-XT Ancillary Board is compatible with all Sigma A-XT control panels.

The board provides volt free normally open contacts allowing control of sub-systems and plant remotely from the main panel over a two wire data bus.

Ancillary boards require only a two core data cable from the main control panel and a two core power cable from the main panel.

Up to 7 Ancillary boards can be connected to a control panel and each is allocated an address from 1 to 7 using a binary coded DIL switch. The total length of the data cable from the main panel to the last repeater must not exceed 4000 feet.

A mixture of status units and Ancillary boards, up to a maximum of 7 of each type, can be connected to the serial data bus.

Syncro ASM

Marine & Offshore Analogue Addressable 1-2 Loop Control Panel



Syncro ASM Features

- 16 zonal LED indicators
- 2 programmable sounder circuits
- 5 programmable inputs
- 3 programmable relays
- 3A power supply
- Large graphic display
- Real time clock
- Powerful, network wide cause and effects
- Sensitivity adjustment and Drift Compensation
- Apollo and Hochiki protocol
- Same look and feel as Syncro range
- Stores 1000 last events in event log
- Compact, stylish enclosure
- Installer friendly, removable equipment chassis
- Different language and character set variants available
- Fully EN54-2 and EN54-4 compliant

Syncro ASM Overview

Based upon the popular Syncro AS single and two loop analogue addressable fire control panel, the Syncro ASM is certified with a host of classification societies and is Marine Equipment Directive approved.

Compatible with marine approved devices manufactured by Apollo Fire Detectors and Hochiki, Syncro ASM provides a cost effective and scalable solution for all marine fire alarm systems.

Up to 64 Syncro ASM control panels may be networked to provide integrated control and indication of over 16000 fire alarm points.

The optional Voyage Data Recorder interface outputs standard NMEA 0183 protocol and can be fitted inside any control panel on the network.

Suitable for all small to medium sized vessels, Syncro ASM control panels can be expanded and networked to become part of much larger systems if the need arises, therefore providing a future proof solution for any vessel.

With its large graphical display and ergonomic button and indicator layout, the Syncro ASM control panel is simple and straightforward to understand for installers, commissioning engineers and end users alike.

Compatible Equipment & Extras



Supports Apollo Detectors & Devices



Supports Hochiki Detectors & Devices



Syncro View Marine

See DS69



Voyage Data Recorder Interface

See DS92



Facilities

- Expert design advice
- Mechanical engineering design
- Artwork and printing design
- Documentation
- Electrical engineering
- Electronic engineering
- Sheet metal fabrication
- Powder coat finishing
- Metal finishing
- Silk screen printing
- Wire looming
- Electrical safety testing
- Technical support

From the initial design process ▶

▼ To sheet metal fabrication

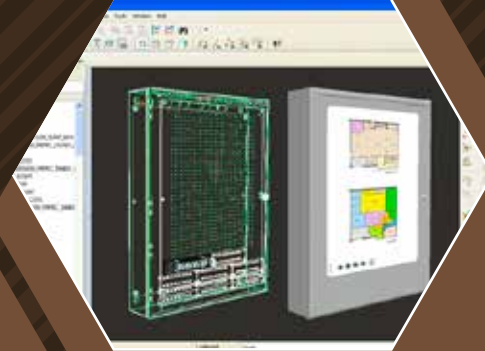

▲ To painting and printing

◀ To panel construction

One of the key areas of our business is the design and manufacture of bespoke equipment. Kentec has considerable expertise in this field with 30 years experience, so you can be certain that all custom engineered product will be designed and built in accordance with your exact requirements and our strict ISO 9001 approved quality procedures.

All custom built equipment is project managed by our engineering department, using the latest software to produce electrical, mechanical and construction drawings to the customers specifications.

We have a dedicated design and manufacturing area for the construction of bespoke product which allows us to offer better service to our customers including factory acceptance testing.

Our skilled and dedicated production engineers build each bespoke product to very high standards and to specifications driven by our customers.

We have full control at every stage allowing us to offer industry leading delivery times and with quality you can have confidence in.



Applications

- Smoke Damper Control Panels
- Composite Relay Units
(c/w Resettable Latching Relay & Firemans Switch)
- Sprinkler System Indicator Panels
- Pump Status Indicator Panels
- Firemans Control Switch Panels
- Analogue/Addressable Interface Units (with or without integral PSU)
- Mimic Repeat Indicator Panels (perspex/metal, metal only, black & white or multi-coloured)

◀ Choose your Finish



◀ Choose your Specification



Choose your Colour ▶





Kentec Electronics Ltd

Units 25-27 Fawkes Avenue Questor

Dartford Kent DA11JQ England

T +44 (0)1322 222121 **F** +44 (0)1322 291794

E sales@kentec.co.uk **W** www.kentec.co.uk



Certificate No. FM 32987
BS EN ISO 9001:2008



Certificate No. EMS 518118
BS EN ISO 14001:2004



Certificate No.360
BS EN ISO 9001:2008



Fire Industry Association



KM 73505
KM 96761



INVESTORS
IN PEOPLE

