

User Guide



EN

Document No: 0044-117-01
www.ffeuk.com

Contents

1. The TalentumTT²	p.3
Features	p.3
2. Specification	p.4
Light Source Performance	p.4
Operational Environment	p.4
Environmental & Personal Protection	p.4
3. Safety Warnings	p.5-6
4. Equipment	p.7
5. Charging the TalentumTT²	p.8
6. Maintaining the TalentumTT²	p.9
7. Introducing the TalentumTT²	p.10-13
8. Testing a Talentum Flame Detector	
Setting up a Talentum Flame Detector Test	p.14
Testing an IR2 or IR3 Talentum	p.15-16
Testing a UV/IR Talentum	p.17
9. Recalibrating a Talentum Flame Detector	p.18-21
Calibration Errors	p.22-24
10. Test Data Log	p.25
11. Open Software Agreement	p.26
12. Maintenance and Servicing	p.27

I. TalentumTT² Overview

This user guide describes the proper use of the FFE TalentumTT², which is intended to

- Precisely simulate a real flame's spectral emissions to test that a Talentum Flame Detector is responsive to the presence of a flame.
- Calibrate a Talentum Flame Detector to be appropriately sensitive to the presence of a flame.

Features

- **Flame Detector Test**
 - Test both IR and UV/IR Flame Detector Models
 - Tests installed Flame Detectors up to 6m away
 - Designed to simulate a real fire, not the sun or artificial light
 - Broad-spectrum test: UV, visible, near IR, Mid IR frequencies
 - Flickering multi-spectral output
 - Solar spectrum profile not present in the output
- **Flame Detector Re-Calibration**
 - If a Flame Detector fails a test, it can be recalibrated on-site, you will need a Calibration Kit to do so
 - Flame Detectors can be recalibrated in-situ or dismantled if required
- **Test and Calibration Data**
 - The TalentumTT² Unit stores data on tests and calibrations
 - Data can be retrieved via USB interface and sent to FFE Support
 - FFE Support can use the data to aid in specific support enquires and product improvement
- **Portable hand-held torch body with convenient USB charging**

2. Specification

Light Source Performance

Light Source Power		1x20W 2x10W
Spectral Response	UV Visible Near IR Mid IR	200nm to 4.3 μ m
Test Range		1 - 6 m Typical

Operational Environment

Operating Temperature	-10°C to +55°C
Hazardous (Ex) Areas	Not suitable for use in hazardous areas
IP Rating	IP54

Battery Performance

Recharge Time	Around 2.5 Hours
Duty Cycle (IR-Only)	40 x 30-Second Tests (approx.)
Duty Cycle (UV/IR)	30 x 30-Second Tests (approx.)

Environmental & Personal Protection



Li-ion



Recycle raw materials instead of disposing of them as waste.

The unit, accessories, and packaging should be sorted for environmentally friendly recycling.



This product emits IR, visible, UV-A, UV-B & UV-C radiation. Care should be taken to avoid pointing the light emitted at people, animals, or sensitive equipment.

3. Safety Warnings

Per the Talentum User Guide, users should conduct regular maintenance and testing of Talentum fire detection products according to the risk and environment in which the product(s) are located. The frequency of such maintenance and test schedule should be revisited at regular intervals to ensure that it remains appropriate.

Please be aware that the TalentumTT² does not have an (Ex) approval for hazardous areas. A permit is required to test a detector in such areas. Alternatively, the Flame Detector should be removed and placed within a safe location to perform the test.

Testing of a Flame Detector should only be conducted where it is safe to do so and by personnel with appropriate training and equipment.

Ultraviolet radiation may cause harm. Please avoid any direct exposure to eyes and skin when using the TalentumTT²

This device contains lithium-ion batteries that are not replaceable by the user; the following care should be taken:

- Do not disassemble or allow any intrusion into the case.
- Keep dry, do not immerse in liquid.
- Do not charge on a flammable surface or in an explosive environment.

The FFE TalentumTT² has been designed to work specifically with Talentum Flame Detectors. FFE cannot guarantee the capability to accurately test other manufacturers' Flame Detectors.

The TalentumTT² is only intended for use with the following devices.

- I658I IR2 Flame Detector
- I657I IR2 Flame Detector - Intrinsically safe (IS)
- I651I IR2 Flame Detector - Flameproof (Exd)
- I650I IR2 Flame Detector - Stainless steel
- I654I IR2 Flame Detector - Stainless steel flameproof (Exd)
- I6589 IR3 Flame Detector
- I6579 IR3 Flame Detector - Intrinsically safe (IS)
- I6519 IR3 Flame Detector - Flameproof (Exd)
- I6509 IR3 Flame Detector - Stainless Steel
- I6549 IR3 Flame Detector - Stainless steel flameproof (Exd)
- I659I UV/IR2 Flame Detector
- I652I UV/IR2 Flame Detector - Flameproof (Exd)
- I653I UV/IR2 Flame Detector - Stainless Steel
- I656I UV/IR2 Flame Detector - Stainless Steel, Flameproof (Exd)

Note: The FFE TalentumTT² is not rated for use in Hazardous areas. Intrinsically Safe and Exd devices should be moved to a safe area when using the product.

4. Equipment

Task	Required Equipment	Recommended Equipment	Note
Testing a Talentum	A Test Unit (Supplied)	-	IR only and UV/IR testing require only equipment supplied in the kit.
Recalibrating a Talentum	A Test Unit (Supplied) A Calibration Kit (Supplied separately, Contact FFE to order) .	-	The Calibration Kit (Supplied separately, Contact FFE to order) includes a Shroud and a Calibration Cable. May be able to bring older Talentum units back into normal operation if they have drifted out of calibration and no longer indicate a fire when tested with a TalentumTT ² .
Charging Test Torch	USB data and charging cable (Supplied) . Any USB-A (standard) charging port such as a USB mains charger (Not Supplied) .	USB data and charging cable (Supplied) . A Fast Charge capable USB-A (standard) charging port such as a Fast Charge USB mains charger (Not Supplied) .	A mains charger is not supplied. Use the USB data and charging cable supplied.
Reading Test Torch Logs	USB data and charging cable (Supplied) . Any computer, tablet or other device (Not Supplied) that supports reading from USB hard drives with a USB-A (standard) data port of any speed (USB 1.1+).	USB data and charging cable (Supplied) . Any computer, tablet or other device (Not Supplied) that supports reading from USB hard drives with a USB-A (standard) data port with USB 2.0+ speed.	Reading the logs is not needed for normal operation. Use the USB data and charging cable supplied to connect the torch to your PC.

5. Charging the TalentumTT²

The TalentumTT² uses lithium-ion batteries that must be charged by plugging the USB cable into the USB-C port of the unit and connecting the other end to a Fast Charge capable USB socket.

The LED next to the USB-C connector will be solid green while the TalentumTT² is charging, turns off when charging is complete and will flash if the battery is unable to charge due to a fault. In case of a fault, try an alternative charger and if it is not possible to charge the TalentumTT², return it for service.

6. Maintaining the TalentumTT²

- Charge regularly and avoid leaving with a low battery.
- Check for significant damage or soiling before use; discontinue use if the item is more than cosmetically damaged or soiled.
- Check the USB cable for damage before use, replace with Fast Charge and data transfer compatible USB-A male to USB-C male cable if required.
- Do not disassemble the TalentumTT².
- Do not use liquids or abrasives to clean the TalentumTT².

7. Introducing the TalentumTT²

Getting to know your TalentumTT²

The TalentumTT² user interface consists of an LCD screen and seven control buttons, as illustrated below:



Power-on Screen

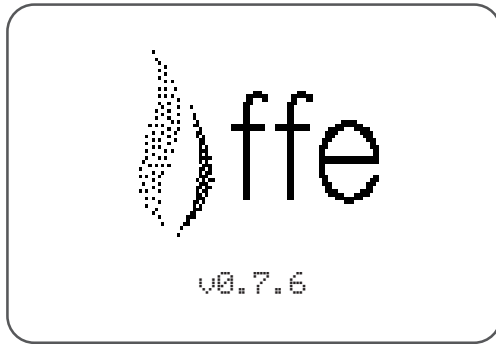

Whilst the unit is powering up, the battery will be checked before taking you to the main screen.



The main screen will allow you to select either a **IR test**, a **UV/IR test** or to **recalibrate** your Talentum Flame Detector.

Pressing the **Up** or **Down Arrow** keys will change the current selection. Pressing the **OK** button will select a menu item. To return to a previous menu, press the **Back** button.

Main Menu

Selecting **Menu Menu** will bring up the main menu.

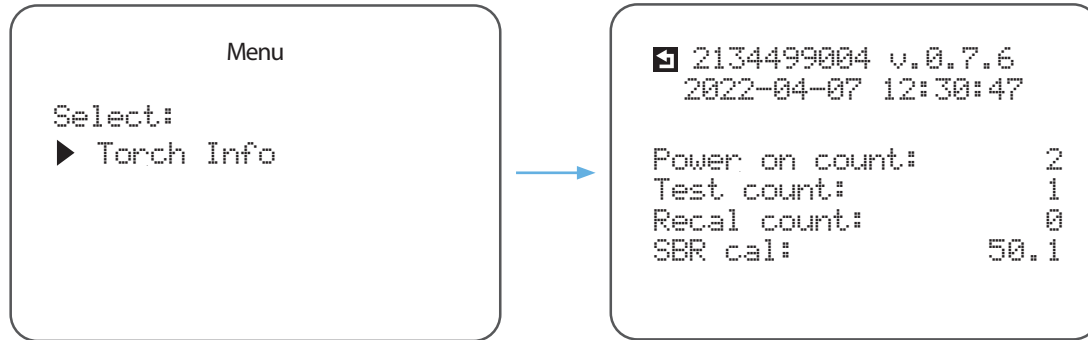

Selecting **Torch Info** will bring up a screen similar to the one shown above.

Switching off the Unit

To power off the TalentumTT² press the **Power** button. It will turn itself off when it has finished a test or recalibration, if the user is inactive in a menu for 30 seconds or if the TalentumTT² has encountered an error condition.

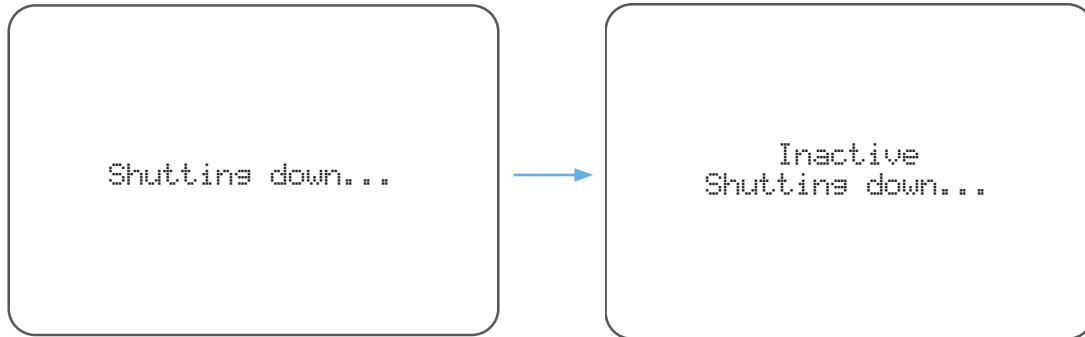

8. Testing a Talentum Flame Detector

Setting up a Talentum Flame Detector Test

Hold the TalentumTT² as still as possible at approximately 1-6m from the Flame Detector, close to the centre of the Detector's line of sight, taking care to point the unit emitter towards the Detector's sensors. Some adjustments may be required to find the ideal position and distance for a specific Detector.

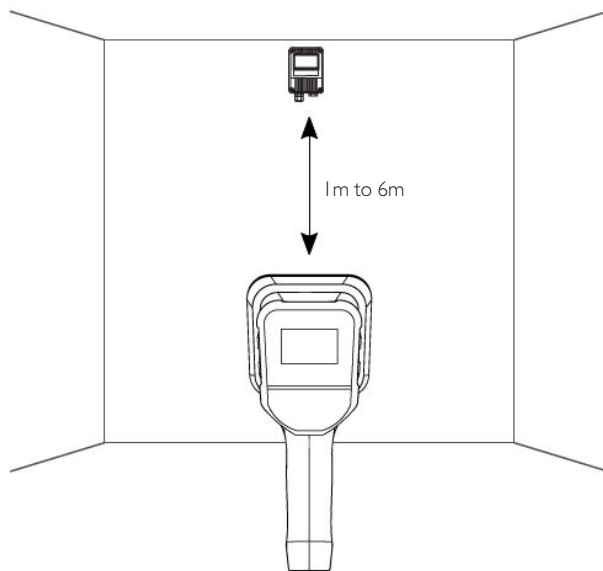

Note: Ultraviolet radiation may cause harm. Please avoid any direct exposure to eyes and skin when using the TalentumTT²

Testing an IR2 or IR3 Talentum

The IR only test does not use the UV bulb in the TalentumTT² and is the recommended test for IR2 and IR3 Talentum Flame Detectors.

After selecting **IR Only Test** from the menu the TalentumTT² will prompt for confirmation:

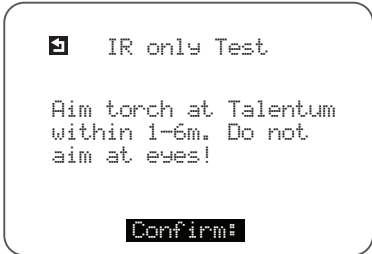

The IR bulbs are turned on full power for several seconds to warm them up to operating temperature.

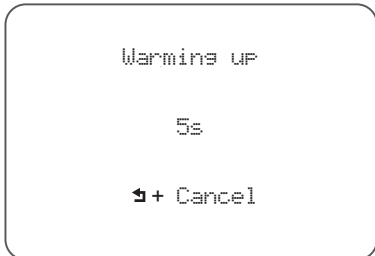

Press the **Trigger** button to start the test, or **Back** to cancel. When the test starts the screen will change to show:

The number on the bottom row will count down in seconds. It is not expected that the Talentum Flame Detector will react to this stage of the test.

You should use this time to ensure you have the correct alignment and distance between the TalentumTT² and the Flame Detector under test as per 'Setting up a Talentum Flame Detector test' on [page 14](#).

Once warming is complete, the test moves onto the main operation phase, and the screen will update to display:

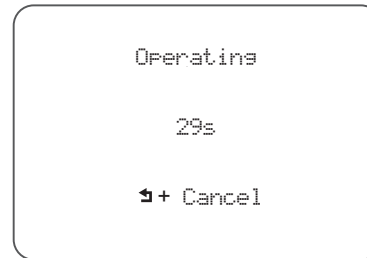

The number in the bottom row will again count down in seconds. The Flame Detector is expected to go into a Fire state during this test. You may press the **Trigger** or **Back** button to stop the test anytime; usually, once the test is successful.

If the Flame Detector does not go into fire during this test, it could indicate a problem with the Flame Detector or how the test was performed.

Check that your alignment and distance between the TalentumTT² are within the specified tolerances for the Flame Detector. Remember that there is a range of distances between the TalentumTT² and Flame Detector where it should trigger, for example, try reducing the distance between the TalentumTT² and the Flame Detector.

If you are unable to achieve a Fire state you may need to recalibrate the Flame Detector. Refer to the section 'Recalibrate a Talentum Flame Detector' on [page 18](#).

When the counter reaches zero or when the **Trigger** or **Back** button is pressed to finish the test, the IR bulbs are turned on at full power for ten seconds to recondition them, extending their working life.

The screen at this point reads:

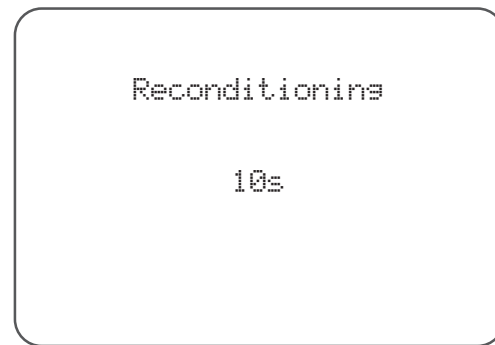

The number in the bottom row will count down in seconds, and when it reaches zero, the TalentumTT² will turn itself off.

Testing a UV/IR Talentum

For UV/IR Talentum Flame Detectors the test makes use of the UV lamp in the TalentumTT². As UV light can be harmful to the eyes, it is recommended that the TalentumTT² is pointed away from people during this procedure. The first two screens are modified to warn about the presence of UV-C light:

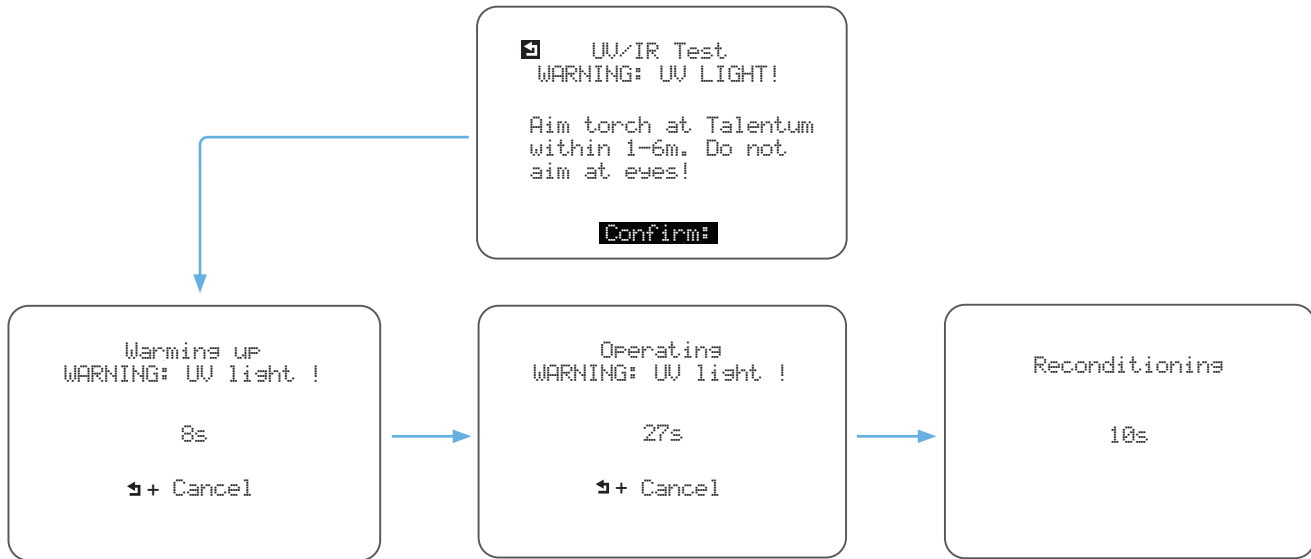

9. Recalibrating a Talentum Flame Detector

Recalibration is a valuable feature for this TalentumTT² design, which may help resolve any issues found while performing the more normal testing of a Talentum Flame Detector. This gives additional flexibility to potentially eliminate the need to remove/replace a Flame Detector.

Remove the front cover of the Talentum Flame Detector by loosening the four bolts with a 5mm Allen key. Carefully peel back the sticker surrounding the DIL switches by using a small flat-bladed screwdriver to reveal the 10-pin maintenance connector to the right of the DIL switches.

Insert the calibration cable into the maintenance connector, noting that the connector is keyed so will only fit one way round.

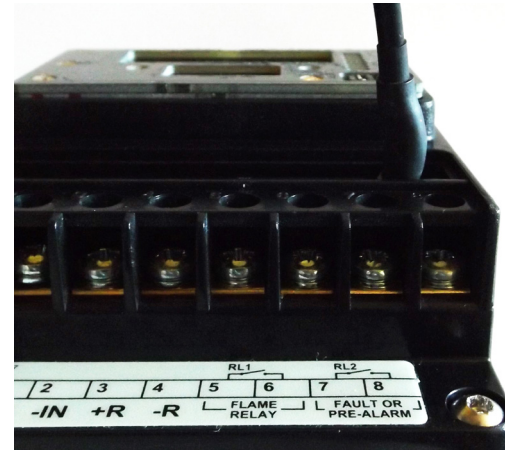

Connect the other end of the calibration cable to the USB-C socket on the top side of the TalentumTT².

A Shroud is needed during the calibration procedure to prevent ambient light from influencing the test. Place the Shroud provided over the front of the TalentumTT². The large end fits over the front of the TalentumTT², and the small end fits over the Flame Detector window.

Holding the Shroud in place to cover the Flame Detector window, select **Recalibrate Talentum** from the **Main Menu** and press **OK**.



The following confirmation screen will be shown. Press the **Trigger** button to start calibration or the **Back** button to cancel.

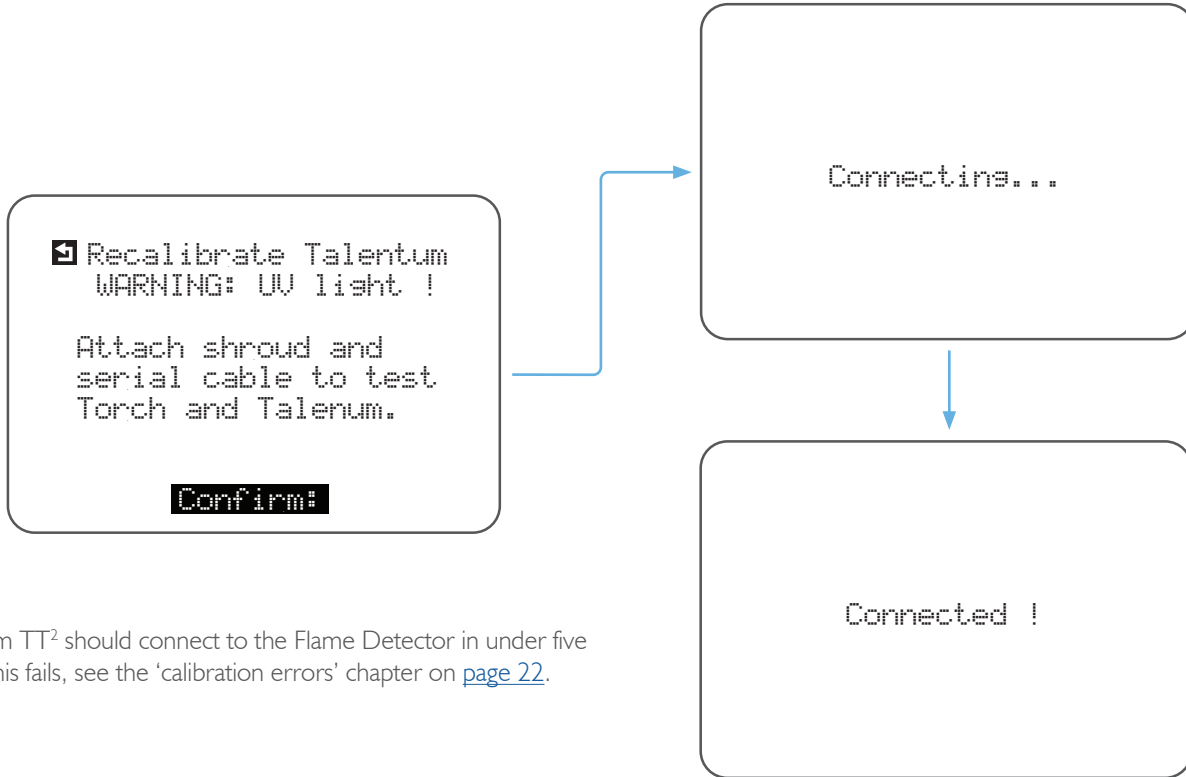

The Talentum TT² should connect to the Flame Detector in under five seconds. If this fails, see the 'calibration errors' chapter on [page 22](#).

Recalibration from this point is a largely automatic procedure, and the TalentumTT² display indicates what it is doing throughout. This process takes approximately one minute to complete. The following sequence of screens should be displayed.

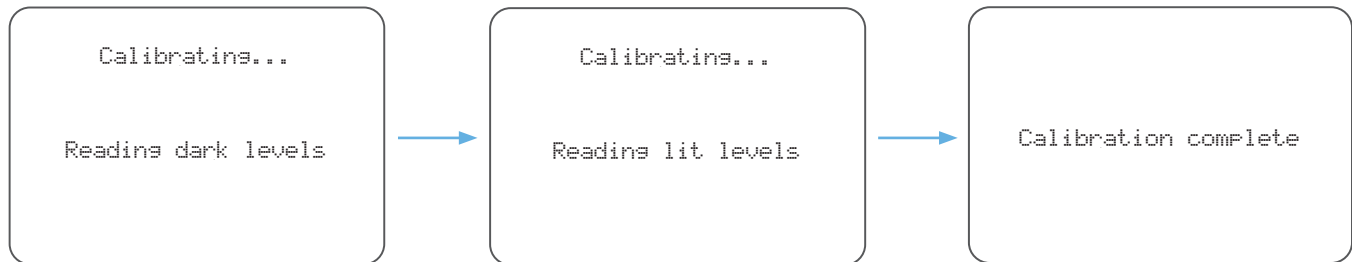

Calibration Errors

An error may occur during the calibration process. Any error will be displayed in the following format:



The error message will be displayed until the **OK** button is pressed and is not subject to the usual 30-second timeout and the reason for the error is also stored in the calibration log. If multiple errors occur, they are displayed in sequence. Once the **OK** button has been pressed for the last error message, the TalentumTT² will turn itself off.

Below is a list of the possible error messages, along with more detail on their meaning:

- **Shroud not fitted! Check the shroud**
Check that the Shroud is fitted to the TalentumTT² and the Flame Detector correctly.
- **Unable to connect to Talentum**
The TalentumTT² cannot communicate successfully with the Flame Detector. Check that the cable is correctly connected to both the TalentumTT² and the Flame Detector maintenance port.
- **Could not reset Talentum**
The TalentumTT² cannot reset the Flame Detector. Again, check that the cable is correctly connected and has not been damaged. If it appears correct, the Flame Detector may need servicing.

- **Reading factory calibration**

The TalentumTT² could not read factory calibration information from the Flame Detector. Some Talentum Flame Detectors may not have factory calibration stored; that will not cause this error. The Flame Detector may need servicing.

- **Parsing factory calibration**

The factory calibration information read from the Flame Detector was invalid. The TalentumTT² will act as if no factory calibration information was present and will continue to recalibrate. This message will only be displayed once recalibration is finished.

- **Could not write new serial number**

If a Flame Detector has no factory calibration information stored (which includes its serial number), the TalentumTT² will generate a new serial number for it. This error indicates that the TalentumTT² could not write the new serial number back to the Flame Detector. The Flame Detector may need servicing.

- **Could not read unit type**

The TalentumTT² could not read the unit type information from the Flame Detector. The Flame Detector may need servicing.

- **Cannot recalibrate Talentum**

The Flame Detector is of a type that has only a single IR sensor (calibration requires at least two IR sensors) or does not have a recognised part number.

- **Unknown unit type**

The TalentumTT² does not recognise the unit type returned by the Flame Detector and cannot recalibrate it. Check the actual type of the Flame Detector; its recorded unit type may have become corrupted, and the Flame Detector may need servicing.

- **Invalid part number**

The Flame Detector has factory calibration information that includes a part number that fully identifies the type of Flame Detector. This part number contains non-numeric characters, which is not valid. The Flame Detector should be returned for servicing.

- **Could not read Talentum version**

The TalentumTT² could not read the firmware version from the Flame Detector. Since this is not critical information, the recalibration will continue. This message will only be displayed once recalibration is finished.

- **Could not read cal history**

The TalentumTT² could not determine where or whether information about the last calibration performed on the Flame Detector is stored. Since this is not critical information, the recalibration will continue. This message will only be displayed once recalibration is finished.

- **Could not get sensor readings**

An error occurred while reading the recorded sensor values from the Flame Detector.

- **Sensor readings too low**

The average of the sensor readings is improbably low. The Flame Detector should be returned for servicing.

- **Sensor readings too high**

The average of the sensor readings is improbably high. The Flame Detector should be returned for servicing.

- **Sensor readings too noisy**

The variation in the sensor readings is improbably high. The Flame Detector should be returned for servicing.

- **Unit overheating**

The temperature in the TalentumTT² is too high. Recalibration will be abandoned for safety. Allow the TalentumTT² to cool down before attempting another test or recalibration. The bulbs heat up during use; running them constantly without a short break could cause the TalentumTT² to shut down.

- **Could not write calibration**

The TalentumTT² could not write the calibration values back to the Flame Detector. The Flame Detector may need to be returned for servicing.

- **Could not write cal history**

The TalentumTT² could not write information about this calibration back to the Flame Detector.

10. Test Data Log

The TalentumTT² stores data to help with servicing faulty devices and to help improve our products. This data is intended only for use by FFE.

The TalentumTT² stores two logs of data internally:

- Test operation data – contains data on which tests were run and how the TalentumTT² operated during the tests.
- Calibration data – contains data on recalibration operations which have been carried out.

To retrieve the data logs first, before powering the TalentumTT², attach a USB cable to connect the USB-C port of the TalentumTT² to the USB port of a computer (Windows/Apple/Linux OS supported).

Press the **Power** button for 2 seconds; the screen will display 'Connecting to PC' as below:

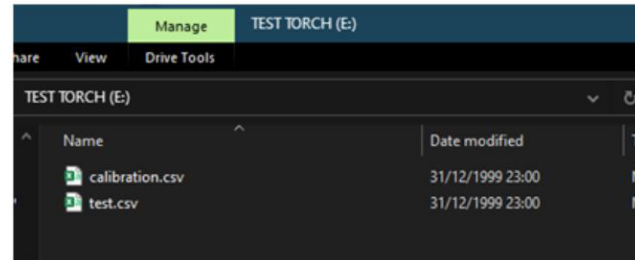

On the computer, the TalentumTT² will present itself as a read-only USB drive containing two files, *calibrations.csv*, and *tests.csv*.

Copy them from the TalentumTT² to local storage, ready to upload to FFE.

11. Open Source Software Agreement

LUFA Library
Copyright (C) Dean Camera, 2021.

dean@fourwalledcubicle.com
www.lufa-lib.org

Permission to use, copy, modify, and distribute this software and its documentation for any purpose is hereby granted without fee, provided that the above copyright notice appear in all copies and that both that the copyright notice and this permission notice and warranty disclaimer appear in supporting documentation, and that the name of the author not be used in advertising or publicity pertaining to distribution of the software without specific, written prior permission.

The author disclaims all warranties with regard to this software, including all implied warranties of merchantability and fitness. In no event shall the author be liable for any special, indirect or consequential damages or any damages whatsoever resulting from loss of use, data or profits, whether in an action of contract, negligence or other tortious action, arising out of or in connection with the use or performance of this software.

I2. Maintenance and Servicing

FFE offers a service package for the Talentum TT2. We recommend that the Talentum TT2 is serviced every 2-3 years. Such a service would include replacement of both the batteries, all three bulbs, as well as all O-rings and gaskets.

Lithium-ion batteries have a useable life of around 2-3 years or 300-500 charge cycles, whichever occurs first. One charge cycle is a period of use from fully charged, to fully discharged, and fully recharged again. Beyond 3 years without a service the user should expect to see a decrease in battery life with fewer uses per charge. Overall performance remains in specification due to the built-in self-checks performed by the TT2 before each test, however the number of tests possible on a full charge of the batteries will be reduced.

Bulb life depends on several factors, primarily prolonged use. We expect the bulbs to last for up to 100 hours, equivalent to 12,000 tests. The replacement of the bulbs can be a delicate process and requires calibration of the TT2 once complete so this process should be completed by FFE. O-rings and gaskets age and become brittle, by replacing these at regular intervals FFE ensures the Talentum TT2 remains sealed against ingress to the sensitive internal measurement circuit.

Please contact your local sales office for more information on how to utilise our service option.